



Manufacturer of Synthetic Harnesses and Tack

MASTER CATALOG

QUALITY | SERVICE | DELIVERED



Made In USA



Colleen Layton (driver)
Dawn Pontz Photography

Prices subject to
change without
notice, confirm prices
when placing order



Made in USA



We ship with UPS and
9-5 (local delivery) daily

☎ PH: 610-273-7370 | 📠 FAX: 412-504-6014 | ✉ sales@yonies.com

435 Churchtown Road, Honey Brook, PA 19344

Hi! Welcome to our Catalog!

We're constantly trying to improve things, so if you find something you would like changed please let us know.

Some items to note in the catalog:

- **Deluxe Road Harness** - page 73
(a padded harness for the road horse)
- **Knee Spreaders** - page 28
(for the horse that hits his knees, as a training aid)
- **Bowman Bits** - page 35
- **NEW ITEM** - Construction Pouches - page 6
And much more! If you can't find it, just ask!
- **Index** is located on page 87.

HAVE A BLESSED YEAR!

THE STAFF AT YONIES

MISCELLANEOUS: PAGES 6 - 15

HALTERS & TACK: PAGES 16 - 20

RACE: PAGES 21 - 31

BITS: PAGES 32 - 35

PLEASURE DRIVING: PAGES 36 - 62

HEALTH: PAGES 63 - 64

AMISH DRIVING: PAGES 65 - 76

AMISH WORK: PAGES 77 - 78

DRAFT WORK: PAGES 79 - 85

DRAFT SHOW: PAGE 86

ABOUT YONIES...

Yonies Harness Shop is a family-owned business based in the rolling hills of Eastern Lancaster County in Honey Brook, Pennsylvania.

PURPOSE

Yonies manufactures synthetic harness and tack products to the Amish and Mennonite communities as well as the Harness Racing and Pleasure/Combined Driving communities throughout the world.

EARLY HISTORY

A young boy born into the Daniel Stoltzfus family was blessed to have 2 sisters and 7 brothers. Jonathon was chosen at the age of 12 to help his older sister sew buttons onto his and all his brothers pants, shirts and coats. As the years went by Jonathon began to like sewing so much that he found other ways to satisfy his interest and started producing Amish buggy harnesses. Jonathon soon decided to turn his new endeavor into a business and Yonies Harness Shop was established in 1992.

WHY YONIES?

Thank you for asking! Yonie is derived from the Hebrew language of Yoni pronounced (YOH nee) which is short for Yehonatan pronounced (yeh ho NAT an). Yehonatan is the Hebrew form of the popular name Jonathan. So we can see that the short English and Amish name for Yonie is John and long form is Jonathon. Yonie is the nickname for John or Jonathon similar to Bob for Robert and Bill for William. The founder of Yonies Harness shop is Yonie Stoltzfus in Pennsylvania Dutch language or John or Jonathon Stoltzfus in English.

Yonies added its first employee in 1995. Yonies business mainly grew by word of mouth from various individuals who used and appreciated our products. We are very grateful for everyone that has recommended us over the years! And we do know who you are!

LIFESTYLE

A unique combination of traditional and modern lifestyles is common in our area where horse and carriages interact with cars and trucks on the streets. Lancaster County is internationally known for its skilled artisans, impeccable craftsmanship, and dedicated work ethic. We aim to carry on that tradition by producing the highest quality synthetic harnesses and tack on the market today.

OFF-GRID

Yonies manufacturing shop is completely independent of the electrical grid. We create all the power we use. Additionally, the majority of our team members live near the shop so they walk, or use their scooters to go to work. Others that live a distance from the shop do carpool with a driver. It is a place where craftsmen can work at their trade and still watch their neighbors as they work in the fields, planting, cultivating and finally harvesting the crops of corn and hay, seeing the beauty of nature and drawing inspiration for their work.

GROWTH

Yonies has grown from a home based necessity to a small worldwide business in 30+ years (since 1992). We now have employees and home based sub-contractors who also have employees. We can design, manufacture and produce whatever you desire.

TERMS

- All orders must be paid in full before shipment leaves our facilities, unless credit has been approved.
- We accept Master card, Visa, money orders, checks, or cash.
Returned checks will be subject to a \$20 fee.
- Net 30 days on approved accounts. 1.5% interest to be charged on all past due accounts. Owners of delinquent accounts will be responsible for all additional fees, including, but not limited to, collection fees (up to 50%), and legal fees. There is a minimum service fee of \$2.50 per month.
- Any accounts over 90 days past due may be turned over to a collection agency of our choice.

PREPAID SHIPPING

- If you are mailing your order in with a check you can now add shipping. See mail order form (on page 4).
- Orders placed via phone, fax, or email will be charged standard UPS rates. Does not apply to Gates, Brooms, or any over size box. Within the 48 states, for shipping elsewhere please contact us for a shipping quote.

SHIPPING

- Unless otherwise requested, domestic shipments via UPS or a local delivery service and international shipments via either DHL or UPS.

WHOLESALE ACCOUNTS

- Dealers can be listed on our dealer list online at yonies.com upon request.
- Yes, we do sell wholesale and retail from the same facility. For a list of our dealers please visit our website, www.dealers.yonies.com. Or ask your local supplier if they sell Yonies Equipment. Dealers may offer to fit your horse at your location or theirs (added charges may apply)
- Enquiries Welcome, we are always looking to add more dealers.

RETURNED MERCHANDISE

- All returned merchandise is subject to a 10% restocking charge unless it was our error. You must report shortages and/or overages within 10 days of invoice date or full credit may not be given. All returned merchandise must be accompanied by invoice number and a note requesting exchange or credit. Customer is responsible for all shipping charges. All merchandise returned must be in "as new" condition.

CUSTOM MADE/CUSTOM MFG

- Custom made products - Cannot be returned unless it was our error.
- We do custom manufacturing for your company as well. Please ask for details and prices.
- Customizing products - There is a surcharge of 20% or \$4 (whichever is more) if we need to customize a part.
- (made to order) items are made as they are ordered. Custom surcharge applied if custom made outside of normal MTO specs.

LARGE QUANTITY ORDERS

- Contact us for special pricing on large quantities.

DISCLAIMER

- All prices in this catalog are subject to change without notice. We are not responsible for incorrect prices or descriptions due to typographical errors.
- Colors and photos shown in catalog may be slightly off due to events beyond our control (photography, print, and slight variations in batches). Ask for samples if you need to perfectly match a certain color. Charges may apply for excessive samples of colors.
- All Yonies products are made with the intention of being the best quality available to man. However, as you are most likely aware by now, horses are strong and powerful animals that can cause the highest quality strap goods to break. Your common sense and commitment are vital to the well being of you, your horse, and those around you. Safe Driving!

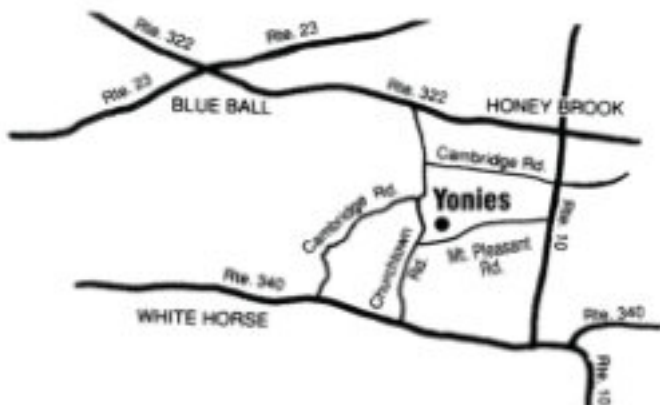

4 CONVENIENT WAYS TO ORDER:



610-273-7370 or 610-403-9241

Phone calls answered 7AM - 4PM Mon to Fri, if no answer, call back in 20 minutes or leave voicemail.



Fax 412-504-6014



sales@Yonies.com



www.yonies.com

(Not everything is on the site yet...have patience!)

Store Hours

MONDAY & FRIDAY: 6 AM - 7 PM • TUES, WED, & THURS: 6 AM - 5 PM

SATURDAY: 7 AM - 2 PM • CLOSED SUNDAY

NO PHONE CALLS ANSWERED ON SATURDAYS

Please call with your concerns, comments or complaints.
If you like our products, tell others, if not, tell us!!

Our harnesses are made using different materials, getting these colors to match completely is impossible, so we have all our colors below. Harnesses are ordered with Bio Color #'s.

Bio vs. Beta?

Bio (Biothane®) and Beta® are made by the same company (Biothane® Coated Webbing).
 Bio = harder, good for trim and buckle pcs.
 Beta = soft. Good for lines and against the horse.

	BIO	BETA	NYLON	LEATHER
High Abrasion Resistance	✓			
Lower Abrasion Resistance		✓	✓	✓
Soft To The Touch		✓		✓
Longer Life	✓			
Easy To Clean	✓	✓		
Light Weight & Strong	✓	✓	✓	
Crack Resistant	✓	✓	✓	

Bio (main color) *Easy to clean; wears well*



CUSTOM COLORS AVAILABLE
 ASK IF INTERESTED

Beta (accent colors) *Easy to clean; softer - used for lines or against the horse*



Vinyl (pads)

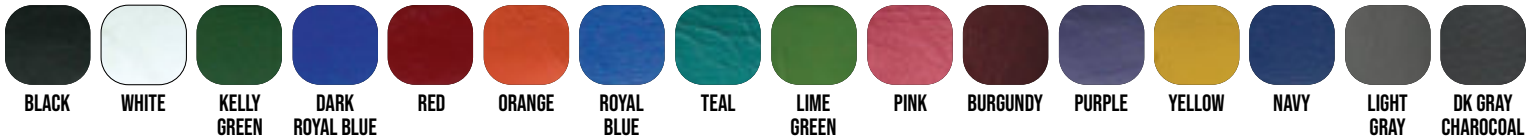

Nylon (nylon buxtans)

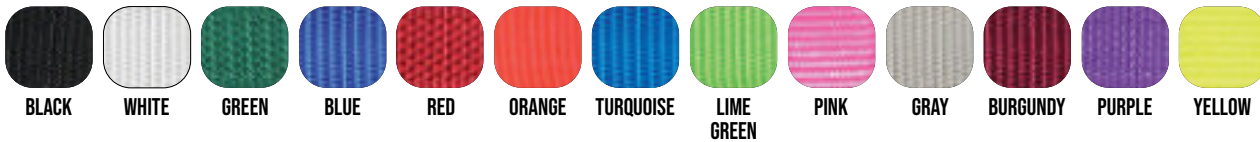

Specialty colors may take a few days (not in stock)

For full Biothane Color Chart go to www.forms.Yonies.com

NOTE:

Colors not 100% accurate due to photography, print quality and slight variations between batches. We try our best, but you may want to stop by or request samples if you need an exact color.

TIRED OF YOUR POUCHES WEARING OUT? TRY ONE OF THESE POUCHES!

NO ROTTING | LONG LASTING | SYNTHETIC (NO LEATHER)

Small Tool/Slap Tacker Pouch

#2202 \$36

Fits the Bostitch Hammer Tacker
mdl #H30-8D6 & H30-8) and more!



*Still using this pouch
16+ months after I
bought it - Incredible!
- Satisfied customer*



Nail Pouch

#2203 \$36



Hammer Holder

#2209 \$17.50



Bit Pouch Organizer

#2212 1 row (shown) \$37

#2210 2 row \$60



Square Pouch Holder

#2208 Left \$33

#2208 Right \$33



Tool Belt

#2215 \$44



MISCELLANEOUS

Synthetic
Long lasting
No Oil

BIOTHANE BELTS

WON'T CRINKLE, WRINKLE, STRETCH OR SMELL!

Wholesale
Inquiries
Welcome



Basket Weave Belts

Black or
Brown only



Everyday Belt

- Made with Biothane® coated webbing
- Designed to last a very long time
- Will not stretch like leather
- Measured from tip to center hole

#6901 - **\$15.50**
1-1/8" wide

Boys Belt

#6961 - **\$16.50**
1" wide.
Sizes from 20" to 28"
(in increments of 2" - 20", 22", 24", etc.)

BELT SIZES:
We stock sizes from 30" to 60" | in increments of 2" (30", 32", 34", 36", etc.)

#6975 50" model - **\$32**
#6976 60" model - **\$35**
Removeable buckle for "cut to length" belts

Lightweight "Gun" Belt

◀ **Softer/Flexible**

Harder/Rigid ▶

Heavy Duty "Gun" Belt



#6910 - **\$38.50**
A nice wide belt.

1-1/2" Durable and soft!



#6906 - **\$49**
Made with a heavy web to prevent "twisting"

1-1/2" Very stiff!



Collar Clock

#87671 - **\$250**
Available in Maroon, Purple, Green and Navy



Cowboy Hat Decoration

#87675 - **\$10**
Available in 4 colors: Maroon, Royal Blue, Green, Silver



Leather Wallets

#84763 - **\$13.50**
Great Gift Item!
Nice Soft Leather Bifold Wallets

Flower Pot Holders

#30061 - **\$35**
29"L x 14"H
Standard Bred with Race Bike
(flowers not included)



Bionic Driving Gloves

Black..... #08254 - **\$?**
Made with top grade, extra supple Cabretta Leather.
Ease of use recommendation by Arthritis Foundation
Call for sizing and availability.



Corner Balls

#01620 - **\$23**



Pen Holders

Single
#84011 - **\$11**
Double
#84010 - **\$13**



MISCELLANEOUS



Grazing Hopples

#7095 - **\$35**
1" wide
Stainless Hardware



Riding Stirrups

#84660 - **\$19.50/pr**
Synthetic - Visalia Style - Color: Brown



Swinging Toggles

#50331 - **\$16.50 ea**



Buckleless Grazing Hopples

Short Model - #7085 - **\$33 ea**
Long Model - #7086 - **\$42 ea**
Pony Short Model - #7090 - **\$26 ea**

No Buckles! Designed to help prevent marks. Easy to use!
1-1/2" wide. Short model is for between the two front legs.
Long model is for from front to rear legs.



Whip Sockets

Stainless Steel
#16501 - **\$16 ea**
Solid Brass
#1
- **\$13 ea**

Grazing Muzzles

Best Friend Muzzle (shown)
#82580 - **\$38 ea**

Nylon Muzzle w/Leather Crown Strap
#82575 - **\$41 ea**



Corn Brooms

- Top quality
- Solid Handle
- Genuine Broom Corn
- Handmade in Lancaster County
- Poplar Handle

Barn #06055 **\$25**
Black #06053 **\$27**
Child #07070 **\$16**



Harness Hooks

Black powder coated steel

5" #30040 **\$8.50**
8" #30043 **\$9**
10" #30041 **\$14.50**
12" #30042 **\$20**
36" #30050 **\$29**

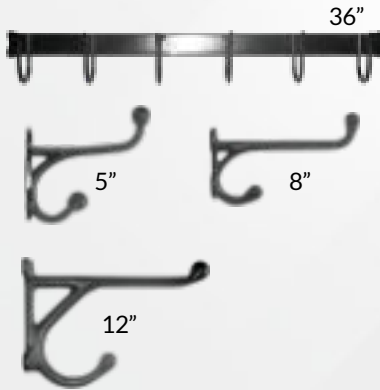

Stainless Steel Battery Clamps

#15300 - **\$1.50 ea**
No more rusty clamps!



Trace Holders

#66900 - **\$6.50/pr**
Fastens with 2 screws (not included)
to keep traces from slipping off



14-Piece Open End Wrench Case

#2200 - **\$32 ea**
Made with strong Codura.
Has Velcro along the top
and bottom to keep from
losing wrenches. Three
Grommets along the top
for hanging in shop.



Sweat Sticks

#44519 - **\$9**
Wooden, curved
Tired of flimsy sweat sticks? Try this long-lasting wooden stick!



Made in the USA!

Stall Gates*

#07380 - 52" wide x 48" high (width includes hinges)

We can also do custom size gates

Call for a quote

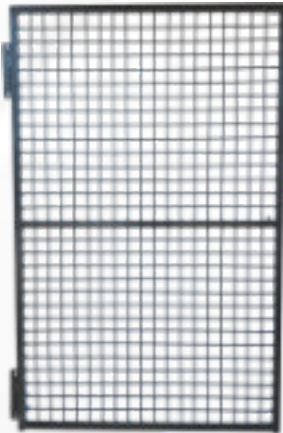

Also available in a full gate size

Call for a quote

Powder coated

1 - 9 pcs. **\$340 ea**
10+ pcs. **\$305 ea**

Call for shipping quote



Heavy Duty (73 lb.)

These are the heaviest duty gates we have ever seen!

Diaper Bag #24997

Mini **\$78**
Horse **\$79**
Draft **\$80**

Includes 2 straps to go to shafts and 2 straps to breeching



BELLS

Biothane Straps - Shiny or Dull (leather look) with Stainless Steel Rings & Chrome over Brass Bells.

29 Bells

#7010 with Chrome Brass Bells **\$425**
#7014 with Brass Bells **\$380**

2" wide strap and 88" in the longest hole

NOTE:

29 BELL SET HAS LARGE BELLS IN THE MIDDLE THAT PUT THE PRICE UP AND GIVE IT A NICE JINGLE

23 Bells

#7012 with Chrome Brass Bells **\$225**
#7013 with Brass Bells **\$216**

1-1/2" wide strap and 85" in the longest hole



Rump Bell

#7006 **\$96**



5" Heart w/ Spots & Bells

#7003 **\$26**



8 Bells

#7023 **\$69**



7" Heart w/ Spots & Bells

#7004 **\$41**



4 Bells

#7022 **\$39**



Keychain Bell

#7027 **\$7.50**



Snap and Bell

#7025 **\$23**



Animal Door Chime

Horse or Dog with Chrome Plated Bells
#7018 **\$13**

Horse or Dog with Chrome Brass Bells
#7019 **\$18**

Door Bell

#7000 **\$72**



LEATHER COLLARS

FOR PATENT LEATHER COLLARS ADD: TO 100 MP - 100 BUGGY 101 EXPRESS & 105 A - \$60
TO 49 1/2 WORK & 69 WORK ADD \$97

Mini & Pony Collars (#100MP)

looks like #101 Express Collar but smaller

- #13600 - 14" **\$78**
- #13601 - 15" **\$78**

Buggy (#100)

looks like #101 Express Collar but not quite as heavy

- #14215 - 16" **\$84**

Express (#101)

Collar & Driving Horse Collar. In stock in most sizes.

- #14123 - 17" thru 20 **\$102**
- #14124 - 21" **\$108**
- #14125 - 22" **\$114**
- #14126 - 23" **\$120**

Kay Collar (Show)

- #14856 - 21" **\$350**

Collar (#105A)

All Purpose Collar for Driving Horse
Built like express collar but heavier padding.
Also has a deeper bed for work hames

- #14574 - 16" thru 20" **\$108**
- #14575 - 21" **\$112**
- #14576 - 22" **\$118**
- #14577 - 23" **\$124**
- #14578 - 24" **\$132**

Adjustable Work Collar (#69)

(each collar fits 3 sizes)

- #14810 - 19" to 21" **\$164**
- #14810 - 20" to 22" **\$164**
- #14810 - 21" to 23" **\$170**
- #14810 - 22" to 24" **\$178**
- #14810 - 23" to 25" **\$184**
- #14810 - 24" to 26" **\$192**
- #14810 - 25" to 27" **\$204**
- #14810 - 26" to 28" **\$246**

Draft Show Collar (#725) - Patent Rim

With your choice of loop & lever opening or closed top with 1 dee ring out the back.

#14850 - Side Dee Rings are an option **+\$28**

- #14862 - 24" **\$315**

Call for prices on other sizes

Work Collar (#49 1/2)

- #14623 - 17" thru 20" **\$136**
- #14624 - 21" **\$144**
- #14625 - 22" **\$150**
- #14626 - 23" **\$158**
- #14627 - 24" **\$166**
- #14628 - 25" **\$178**
- #14629 - 26" **\$190**
- #14630 - 27" **\$204**
- #14631 - 28" **\$218**

SYNTHETIC COLLARS - MADE WITH AN IMITATION LEATHER

*UNDER CONTINUOUS IMPROVEMENT - NEW COLLARS MAY BE BETTER!

BENEFITS: LIGHTER WEIGHT, AND NO OIL REQUIRED.

Driving #125B

- #14918 - 18" **\$88**
- #14919 - 19" **\$88**
- #14920 - 20" **\$88**
- #14921 - 21" **\$92**
- #14922 - 22" **\$96**
- #14923 - 23" **\$102**
- #14924 - 24" **\$108**
- #14925 - 25" **\$112**
- #14926 - 26" **\$118**
- #14950 - Adjustable 20" - 22" **\$106**

Work #75B

- #14418 - 18" **\$116**
- #14419 - 19" **\$116**
- #14420 - 20" **\$116**
- #14421 - 21" **\$122**
- #14422 - 22" **\$130**
- #14423 - 23" **\$140**
- #14424 - 24" **\$150**
- #14425 - 25" **\$160**
- #14426 - 26" **\$172**
- #14427 - 27" **\$184**
- #14428 - 28" **\$196**



PADS

VINYL AND VIN/NEO PADS ARE MADE WITH CLOSED CELL FOAM.
FAKE FUR PADS ARE MADE WITH OPEN CELL FOAM. ALLOW 2 WEEKS FOR FUR PADS.

Saddle Pads

#18000 Draft ExpressBack Pad - fur8" - 48"	\$38
#18001 Draft Back Pad - fur8" - 28"	\$38
#18002 Horse GS5 - fur7" - 20"	\$26
#18003 Horse GS5V - fur/vinyl7" - 18"	\$25
#17910 Horse Vinyl/neoprene7" - 18"	\$25
#17904 Horse Reflective7" - 18"	\$26
#18004 Horse GS3 - fur5" - 18"	\$26
#17912 Pony Vinyl/Neoprene4" - 16"	\$17.50
#18007 Minivinyl/neoprene3" - 15"	\$16



#17910

- MAROON
- RED
- YELLOW
- LIME
- KELLY
- REFL GREEN
- TEAL
- ROYAL
- DARK ROYAL
- NAVY
- TAN
- PURPLE
- BLACK
- REFL BLACK
- CHARCOAL
- REFL SILVER
- GRAY
- WHITE
- CREAM (NOT SHOWN)
- FOREST (NOT SHOWN)
- REFL BLUE (NOT SHOWN)



FOR MORE REFLECTIVE PADS SEE PAGE 65

Breeching or Straight Breast Collar Pads

#18010 DraftDB40 - fur 6" - 48"	\$36
#18011 DraftDB405 - fur 5" - 48"	\$36
#17940 Horsevinyl/neoprene 4" - 40"	\$23
#17906 Horse Reflective 4" - 40"	\$27
#92523 Ponyvinyl/neoprene 3-1/2" x 31"	\$22
#92524 Minivinyl/neoprene 3" x 26"	\$20



#17940

Shaped Breast Collar Pads

#17930 Horse vinyl/neoprene Average V \$37



Neck Strap Pad

#18075 3" x 15" vinyl/neo \$13.50

#17908 Reflective \$19



Super V Breast Pad

#17932 Continuous (shown) Vinyl/Neo	\$35
#17901 Continuous Reflective/Neo (not shown)	\$44
#17931 Split Vinyl/Neo	\$37
#17938 Split Wide Style	\$37

#17932



#17931



#17938



NOTE: All prices subject to change without notice

Crown Pads

#18040 Draft
BC14 - fur 1"4" - 14" Black in stock **\$14**

#18041 Horse
BC10b - fur 1" - 2-1/2" - 10" **\$14**



Top Collar Pads

#18045 Horse
TC50 - fur 1" - 7" - 10" Black in stock **\$20**

#18046 Horse
TC50V - fur/vinyl 1" - 7" - 10" Black in stock **\$20**



Crupper Roll

#18050 One Size Fits Most
CC10 - fur 12" Long Black in stock **\$10**



Belly Band Pads

#18055 Horse
BB22 - fake fur 1" - 3-1/2" - 22" Black in stock **\$27**

#18056
BB22 - vin/neo 1" - 3-1/2" - 22" Black in stock **\$27**



Collar Pads

**21", 22" & 23" colors in stock.
24" black in stock.**

SIZING: For pad size, take collar size plus 2".
If Collar size is under 17", then +1" to size.

#17920 Horse vinyl/neoprene 20" to 22" **\$42**

#17922 Horse vinyl/neoprene 23" to 25" **\$45**

Collar Pad with Vinyl



Also available in sizes from 13" to 19" and Draft sizes
from 23" to 24". **By special order.**

Work Horse Collar Pads

Extra wide for work horse collars

BLACK WITH GRAY INSIDE *will not absorb moisture*

17", 18", 19" #18060 **\$30**

20", 21", 22" #18061 **\$30**

23", 24", 25" #18062 **\$36**

26", 27", 28" #18063 **\$41**

Top Collar Pad #18069 **\$16**

ALL BLACK PADS *will not absorb moisture*

17" - 19" #18080 **\$34**

20" - 22" #18081 **\$37**

23" - 25" #18082 **\$39**

26" - 28" #18083 **\$41**

**NEED A CUSTOM PAD?
NO PROBLEM!**

**SEND A DETAILED DRAWING TO US AND
WE'LL GET IT MADE FOR YOU.**

ASK FOR CURRENT LEAD TIME

SNAPS

Solid Brass Lock Jaw Snap

3/4"#21522 **\$13.50 ea**



Panic Snap, 1"

#10025 **\$4.50 ea**

Great for quick release for on your turn backs.



#56 Snap

5/8"#56021 **\$2.75 ea**

3/4"#56022 **\$2.75 ea**

1"#56024 **\$3.25 ea**



5015 Scissors Snap

3/4"#50173 **\$3.75 ea**

1"#50174 **\$4 ea**



Snap 440SS with Roller, 1-1/2"

#44011 **\$11 ea**



#017 Snap

5/8"#01741 **\$2.50 ea**

3/4"#01742 **\$3.50 ea**

1"#01745 **\$3.75 ea**



Plumes (Pictured 6" - 12")

We stock 6" & 12" in Red, White, Blue (Tri-Colored)

6" #84569 **\$36**

12" #84570 **\$40**

If you order 2, deduct **\$2 ea**

If you order 3, deduct **\$3 ea**

We can also order anything you need Any size up to 12"

Any color - solid, 2-toned, or tri-colored Prices according to volume and size



Bridle Attachment Alone

#84578 **\$8.50**

Installing Attachment to the Bridle - Labor is approx. \$5



Open Eye Snap - 4" S.S.

#23203 **\$5 ea**



2001 Snap S.S.

#20033, 3/4" **\$3.75 ea**

#20034, 1" **\$3.75 ea**



Double End Snaps - 4-3/4"

Solid Brass

#16303 **\$3 ea**

Double End Snap Die Cast N.P.

#16323 **\$1.75 ea**

3 x stronger than brass

Stainless Steel - 4-3/4"

#16333 **\$4.50 ea**



#225 Snap

3/4" #22562 **\$4.25**

7/8" #22563 **\$6**

1-1/8" #22565 **\$6.50**

1-1/4" #22566 **\$6**

1-1/4" Hvy #22537 **\$9**



Name Plates - 7"H x 13" W

#7059 Plain - has No Spots & No Letters **\$25**

#7060 Double Row 3/8" Spots - No Letters **\$43**

#7061 Single Row 5/8" Spots - No Letters **\$36**

A. Name Tag

With Snap or Ring (pictured with 3/4" Letters)

#7064 Plain - without Letters **\$10.50**

See above letter & ornament price to create your own tag

B. Hearts - 5"

#7046 With Single Row of Spots & 1 Ornament **\$16**

C. Hearts - 7"

#7050 With 2 Rows of 3/8" Spots & 1 Ornament **\$32**

D. Hearts - 9"

#7052 With 2 Rows of 3/8" Spots & 1 Ornament **\$42**

Snap Shackle Pulls

#4277 **\$7.50 ea**



Attach these to your snap shackle so you can release them more conveniently. Available in Black or Brown

Snap Shackle Cover

#4276 **\$6 ea**

Fastens with velcro



Snap Shackles w/Safety

Length:

- 1" = 4" long
- 1-1/4" & 1-1/2" = 4-1/2" long

Size is the inside measurement

1" #98043 **\$35 ea**

1-1/4" #98044 **\$36 ea**

1-1/2" #98048 **\$40 ea**



CALL FOR GIFT BASKET IDEAS!

GREAT FOR CHRISTMAS, BIRTHDAYS AND MORE!



MISCELLANEOUS

Ornaments

We can install these for you, just ask!

#5626 - \$3.75 (+ornament) - Basic install only

Texas Star - NP

#504053/4" \$2.25

#504061" \$3

#504071-1/2" \$3.50

#504082" \$5



Noseband Ornament- SS

#503634" \$6.50



Diamond - SS

#50370large (1-3/4" x 3") \$5.50

#50371med (1-5/16" x 2-1/4") \$4

#50372small (7/8" x 1-1/2") \$4

#50373x-small (3/8" x 1") \$2.25



Arrowhead - SS

#503415/8" X 7/8" \$3



Shield - SS

#50376large (2-3/8" x 2-3/8") \$5.50

#50377med (1-2/4" x 1-3/4") \$4.75

#50378small (1-1/2" x 1-1/2") \$4.25



Small Teardrop - SS

#50390 \$8



Thistle - SS

#50394small \$5

#50395med \$5.50

#50396large \$6.50



Maple Leaf - SS

#50399 \$5.50



Horseshoe/Horsehead - SS

#50361 \$4



Lg Hanging Horseshoe/Horsehead - SS

#7056 \$11



Horsehead - SS

#503087/8" \$7.50



Heart - SS

#50368x-small \$3.25

#50365small \$3.75

#50366med \$5.50

#50367large \$5



Daisy - SS

#50355x-large (1-3/4") \$5.50

#50356large (1-1/2") \$4.50

#50357med (1-1/4") \$3.50



Letters

#503221-1/2" h x 1" w \$11

#503231-1/2" h x 1-1/2" w \$12

#503242-1/2" h x 2-1/2" w \$14.50



Rosettes

#02800 Glass Rosettes \$9.50/pr.



AVAILABLE IN | BLUE, GREEN, RED, WHITE

#28013 - 1" SS \$3 pr.

#28008 - 1-1/4" SS \$3.75 pr.

#28009 - 1-5/8" SS \$5 pr.



#27850

Texas Star NP - 1-5/8" \$8 pr.



#27851

Rope Edged
SS - 1-3/4" \$17 pr.



#27852

Heart Shaped
SS - 1-3/4" \$10 pr.



#27860

Wheat Edged
SS - 1-3/4" \$6.50 pr.



#28018

Rope Edged
w/Horsehead
SS - 1-5/8" \$8.50 pr.



#28020

English Ring Style - 1-3/4"
Nickel Plated
over Brass \$42 pr.



#28040

Star Rosette - 1-1/2" & 1-1/4"
w/Rope Edge SS \$7.50 pr.



TRAINING EQUIPMENT

Bitting Rig/training Bridle

#7113 **\$52**



Training Surcingle & Belly Band

Horse & Cob
#4278 **\$280**

This Surcingle is constructed from our normal synthetic products. Constructed with Biothane products and stainless steel hardware.



Training Surcingle & Belly Band

Horse & Cob
#4290 **\$76**

This Surcingle has a nice soft padding with nylon webbing & nickel hardware. Imported.



Training Shackles with Bungees

#7097 **\$18**

Imported.



Robin Cuffy Style

#4285 Saddle **\$295**
#4120 Girth **\$83**

This Saddle was designed by Robin Cuffy



Running W Harness (nylon)

#21290 **\$60**



Long Lines #7209

*Cotton Style - Beta Billets, w/Swivel in hands (pair)
Available in Black or Brown.*

HO (30') **\$94**
PO (25') **\$88**
MI (20') **\$77**



Economy Long Lines #720834

HO (30') **\$43**

Available in Black or Brown. Made with Nylon.

Lunge Line with Snap

30' #6035 **\$35**

Lunge Line with Chain

30' #6037 **\$38**

Side Reins

Side Reins MFG in Beta with Stainless Steel Hardware

Elastic Style - 1" #7215 \$40
Doughnut Style - 1" #7216 \$49
All Beta Conway Style - 3/4" #7217 \$40

Knee Spreaders

#6665 **\$150**

Is your horse a "knee knocker"?

Buxton style knee spreader helps to widen the horse's gait so they don't hit their knees as hard. One strap goes on each side of neck, bottom piece goes between the legs and fastens to the shafts or up to the harness.

- Can be used on either side
- Easy to put on and easy to adjust
- Rubber ring for comfort
- Adjust for your horse's needs.
Not every horse will have the same results



Full Neck Sweat

#11635 **\$39**



5" Neck Sweat

#24594 **\$11**



10" Neck Sweat

#24595 **\$20**



Neck Sweat Gel

#24599 **\$18**



The only thing predictable about a horse is that they are unpredictable.

MISCELLANEOUS

TACK



BL520
BLACK

BR523
BROWN



WH521
WHITE



GN522
GREEN



BU522
BLUE



RD522
RED



OR522
ORANGE



BU521
LIGHT BLUE



GN528
LIME GREEN



PK311
PINK



GRAY521
GRAY



WN521
TUSCAN RED



VI521
PURPLE



YE521
YELLOW

STOCK COLORS

CUSTOM COLORS

Dressage Bridles - without Reins

Pony, Cob, Horse, XL Horse, Draft	#7110	\$58
Caveson Alone	#7111	\$24
Flash with Adapter	#7112	\$8

Note: If #300 Buckles are used on Bridle Add \$10

Riding Bridles - without Reins

Mini	#7190	\$35
Pony, Cob, Horse, XL Horse	#7191	\$43
Draft	#7192	\$44
Bitless Bridles	#7105	\$47

Add Colored trim, spots, crystals, and more to your riding tack! Call us for details!

Halter Bridles - without Reins

Pony, Cob, Horse, XL Horse	#7152	\$76
Draft	#7153	\$79

Note: For Rolled Brow and Nose on Halter Bridles or Dressage Bridles Add \$15

Reins - Riding

Reins - 5/8" x 8' overall - Mini length - No Buckle in Hand	#7196	\$16
Reins - 5/8" x 4' - Pony Length	#7198	\$20
Reins - 5/8" x 5' - Beta	#7200	\$22
Reins - 3/4" x 5' - Beta	#7201	\$22
Reins - 3/4" x 7' - Draft Length	#7199	\$24
Woven Reins - 3/4" x 5'	#7203	\$69
Stops Installed on Reins or Lines up to 10 (5 per side)	#7204	\$14. ⁵⁰
More than 10 Stops each \$1. ⁵⁰		
Reins made with Rein Grip - 3/4" x 5' - Beta	#7202	\$34
Riding Reins - 3/4" x 7' overall - Average Continuous pc. w/ Bumpy Rein Grip & Snaps	#7207	\$31

Riding Breast Collars

Cob & Horse	#7181	\$61
-------------	-------	------

Riding Breast Collar Attachments

Standing	#7185	\$12. ⁵⁰
Running	#7184	\$18

Stirrup Leathers

Regular Beta	#7228	\$25
Deluxe Style	#7230	\$42

Martingales

Standing	#7176	\$21
Running	#7175	\$33

Show Tack

Bridles - White Beta, includes Straight Bit w/o lead	#7235	\$73
In Hand Halter - White Beta w/o lead	#7236	\$51
Leads - White Beta with 30" SS Chain	#7237	\$35
Mini Halter with Lead (black with colored trim)	#7240	\$26



Dressage Bridle



Riding Bridle



Show Tack

*Custom surcharge plus 20% or \$4 minimum on custom colors/sizes. No custom fee if you buy 3 or more identical pieces (same color/size/model).

HALTERS & TACK

Beta breakaway crowns are standard on some of these. Leather breakaways are available.

Barn Halter, with adj chinstrap. Has snap on throat.

Small or Large Mini - 5/8"	#7135	\$35
Pony - 3/4"	#7136	\$39
Cob - 3/4"	#7137	\$40
Horse - 3/4"	#7138	\$41
XL - 3/4"	#7139	\$42
Cob - 1"	#7140	\$53
Horse - 1"	#7141	\$56
XL - 1"	#7142	\$59
Draft - 1"	#7143	\$61

Braze Hardware is Standard. Has an adj chinstrap and beta breakaway crown.

Buckle Nose Halters - Any Size - Black or Brown

Buckle Nose Halter - 5/8" wide (mini size)	#7329	\$37
Buckle Nose Halter - 3/4" wide	#7333	\$44
Buckle Nose Halter - 1" wide	#7344	\$50

Black and Brown in stock. For colors, see below. Stainless Steel hdw is standard.

Buckle Nose Halters - Colors

5/8" wide (mini/Shetland Pony size)	#7330	\$42
Buckle Nose Halter - 3/4" wide	#7334	\$53
Buckle Nose Halter - 1" wide	#7343	\$58

Any Color Other Than Black or Brown

(See Beta Colors Below)



Leather Crowns Only

Mini - 5/8"	#7145	\$6
Horse, Cob, Pony, XL - 3/4"	#7146	\$6
Horse and Cob - 1"	#7147	\$6
XL and Draft - 1"	#7148	\$6
Grooming Halters (not shown)	#7158	\$27

Nylon Halters

w/3/4" White Overlay

Draft (large) 1-1/2"	#10037	\$35
L Horse - 1"	Solid colors only	
Horse - 1"	#10033	\$22
Cob - 1"	#10032	\$22
Pony - 3/4"	#10031	\$18
Foal - 3/4"	#10030	\$18
Mini - 3/4"	#10029	\$17
Mini Foal - 3/4"	Solid colors only	

Solid Color

#10017	\$29
#10014	\$20
#10013	\$20
#10012	\$20
#10011	\$15
#10010	\$15
#10009	\$15
#10008	\$15

Available in Black, Blue, Green, Maroon, or Red. With Snap at Throat.

*Custom surcharge plus 20% or \$4 minimum on custom colors/sizes. No custom fee if you buy 3 or more identical pieces.

STOCK COLORS

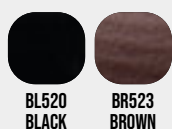

BL520
BLACK

BR523
BROWN

CUSTOM COLORS



WH521
WHITE

GN522
GREEN

BU522
BLUE

RD522
RED

OR522
ORANGE

BU521
LIGHT BLUE

GN528
LIME GREEN

PK311
PINK

GRAY521
GRAY

WN521
TUSCAN RED

VI521
PURPLE

YE521
YELLOW



Barn Halter



Buckle Nose Halter



Nylon Halter



Nylon Halter

Poly Halter

An economical halter of soft 1" poly. Comes complete with buckle crown and snap at throat. Plated hardware. Solid or two toned colors.

Sizes: **horse, yearling or weaning**

Made in Lancaster County

#75142 **\$12 ea**
10 or more SAVE 15% **\$10.²⁰ ea**

Base color: **Black**

All other colors minimum order of 10 pieces*



OVERLAY



NOTE: Yearling and Weaning only in stock in all Black. Any color available if buying 10+ pieces per color/size*

*Custom orders: One week lead time. No surcharge if 10+ pieces per order.

Beta Halter

Constructed of soft Beta with a breakaway crown. Solid Brass Hardware.

Sizes: **horse, cob, yearling or weaning**

Solid Colors

Black or Brown #7125 **\$37**

Colored #7126 **\$40**

Two Tones

Black or Brown w/Trim #7127 **\$41**

Colored w/Trim #7128 **\$43**



BETA HALTER COLORS



OVERLAY - BIO COLORS



Available With Stainless Steel Hardware: **Special Order**

Nylon Halter - Race Style

3/4" Nylon - Stainless Steel Hardware. Crown is lined with a soft lining. Available in: Red, blue, green, & black.

#10019 (Horse Size) **\$25 ea**



Padded Halter

With adjustable chin and snap at throat. The crown and nose have a nice soft padding. Imported by Weaver Leather.

#75143 **\$26 ea**

Available in: **Yearling, Horse & XLarge**

Black with red, blue, pink, green or purple strips.



Show Halter

Made with 1" wide Beta. Double ply with triple stitching. Solid Brass hardware.

#7123 **\$59 ea**

Stainless Steel hardware is special order.

All Beta colors available (no extra charge)



Embroidered Halter

Embroidery on one side #7164 **\$57**

Embroidery on both sides #7165 **\$78**

Embroidery on both sides & nose #7155 **\$99**

Embroidery on nose #7151 **\$57**



Max: 10 letters per side, 20 letters for nose

BUY 10 OR MORE IDENTICAL HALTERS AND SAVE 15%!

Lead Ropes

3/8" x 6' Braided Poly Lead

with nickel plated snap #90085 \$5
Unwrapped 100+ pcs #90085 unwrapped \$2.74

5/8" Braided Poly Lead

with 30" brass plated chain #90087 \$15.50
with stainless steel chain #90224 \$22

6' Cotton Lead

with NP Snap #90061 \$6
with 30" Brass Plated Shank #90086 \$7

8' x 5/8" Braided Poly Lead

with heavy duty 1-1/4"
solid brass snap #90223 \$15.50



Name Plates

(1/2") - Script or Roman lettering

Name Plate only

#08680 \$14

Name Plate installed

#08681 \$18

3/4" Plates also available

Call for prices



Also available with 2 lines of writing

Call for quantity pricing

Beta Leads

Black, Brown, Red,
Orange, Green,
Lime Green, Blue,
Purple, White, Yellow, Pink



Add embroidery to any Beta Leads

#10095 \$24



Solid Brass - Black or Brown - 24" #7162 \$29

Solid Brass - Colored - 24" #7163 \$30

Brass Plated - Black or Brown - 30" #7160 \$18.50

Brass Plated - Colored - 30" #7161 \$19

With 24" Stainless Steel Chain - #7173

Black or Brown \$29

Color \$30

With Solid #225 Snap (solid brass) - #7171

Black or Brown \$16.50

Color \$23

Trim for your Leads - #7167



Trim Colors: Any color

Match your Beta Halters!
\$4.75

Riding Tack with Show Chain or Spots with Colored Trim

LOOKING FOR
CUSTOM RIDING GEAR?

WE CAN HELP!

GIVE US A CALL FOR
MORE DETAILS

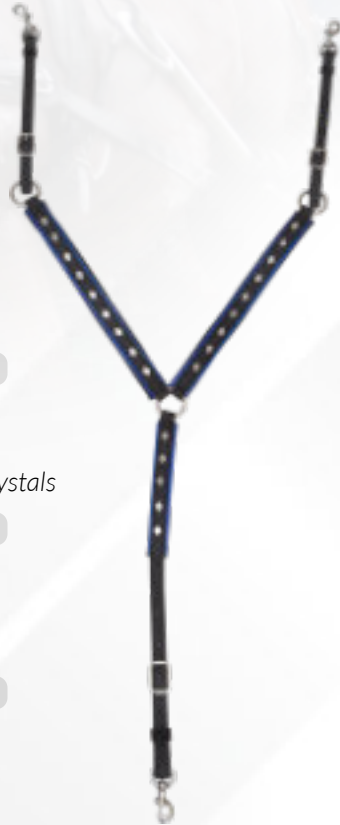

Riding Breast Collar



- Padded w/Trim & Show Chain

#7182

\$182

Riding Breast Collar



- Padded w/Trim & Diamonds or Crystals

#7183

\$110

Riding Breast Collar



- Plain or 2-Toned

#7186 - Padded

\$79

Riding Bridle



- with Trim & Show Chain on Brow

#7193

\$99

Riding Bridle



- with Trim & Diamonds or Crystals

#7194

\$80

Teardrop w/Diamond Ornament (for #7194)

#7195

\$16.⁵⁰



BL101
BLACK



WH101
WHITE



GN101
GREEN



BU318
BLUE



RD318
RED



OR315
ORANGE



TU313
TURQUOISE



GN318
LIME GREEN



PK311
PINK



SI101
SILVER



WN101
BURGUNDY



VI101
PURPLE



YE101
YELLOW

For Training
Equipment &
Long Lines
Trot to pg 15



For Hoof Care
and Liniments
Canter to pg
63 & 64





Amish Jogging Harness with Bridle	#6503	\$605
Amish Jogging Harness no Bridle	#6503	\$417
Quick Hitch Bridle Only	#2153	\$188

Priced with 2 ornaments on bridle. Stainless Keepers on blinds are available (same price).

Pads included. Lines have built-in snaps. Buckle-in crupper. Specify color of harness and choice of ornament.

Choice of ornaments: **Diamond, Texas Star, Heart, or Horseshoe w/Horsehead.**
Specify ornaments: **Diamond, Texas Star, Heart, or Horseshoe w/Horsehead.**

also available in Hackney and Mini sizes

Bridles available With SS Keepers On the blinds.

Shown with SS keepers and full noseband.

Browbands

Hex with Heart Rosettes



Weaver Chain with #28018 Rosettes



Hex with Tex Star Rosettes



Spotted with Glass Rosettes



Rosettes



COLOR OPTIONS:

- White
- Teal
- Red
- Tan
- Gray
- Royal Blue
- Kelly Green
- Purple
- Charcoal
- Dark Royal
- Maroon
- Navy
- Forest Green
- Black



Ornaments On Blinds (optional)



Deep V Fine Breast Collar

#6547 **\$104**

(Black Only)

Pad

#17568 **\$44**

(Choice of Color)

Deep V Fine Breast Collar w/Built-In Padding

#3745 **\$202**

(not shown)



OPTION: SUPER V

NEED HARNESS?



☎ **610-273-7370** (7 AM - 4 PM Eastern)
435 Churchtown Rd., Honey Brook, PA 19344

ORDER TODAY!

Not sure on the total? Just send in the order, we'll mail the product with invoice on the box

WHOLESALE INQUIRIES WELCOME
Prices subject to change without notice.

HARNESSES

All harnesses are priced with open bridles - Can be upgraded to whatever you want.
We only charge the difference between the two parts.

Standard Harness

With Nylon Buxton #6505 **\$475**

With Beta Buxton #6504 **\$495**

- Saddle with Couplers
- Neoprene Girth
- Crupper
- Open Bridle
- Bio/Beta Lines w/Beta Handholds
- Caveson
- Pad, Vinyl with Neoprene Lining

**CALL US TO
DESIGN A
CUSTOM
HARNESS**

Deluxe Harness

With Nylon Padded Buxton #6491 **\$525**

With Bio Padded Buxton #6493 **\$545**

- Saddle with Couplers
- Shaped Girth
- Crupper
- Open Bridle
- Bio/Beta Lines w/Beta Handholds
- Caveson
- Pad, Vinyl with Neoprene Lining
- Padded Buxton!



Upgrades: Like the harness but would want something different? Just find the item you would want and tell us. We'll put it on and only charge the difference. We aim to please!

COMMENTS:

"All we use is Yonies for our racing needs!" - **Crissman-Bier Racing**

"The best harness for the money" - **Bobby Myers**

"I recommend Yonie's Flex Whip to anyone who's tired of breaking whips" - **Dave Palone**

"Yonie's harnesses are durable, easy to maintain and we love them!"
- **Zendt Stables**

"The lines feel great in my hands and I just love the craftsmanship! The best harness for the money" - **Tim Twaddle**

"Yonie's harness' are the best. Beautifully made" - **Syl King**



Crissman-Bier Tack Room

Horse driving is like nuts and bolts...if the driver is nuts, the horse will bolt....

Saddles

Standard Saddle

#6573 **\$102**



Padded Saddle

#6570 **\$160**



Flex Saddle

#6571 **\$138**



All saddles priced without couplers

**PAGE OVER TO
PAGE 29 FOR PADS**

Sulky Parts

Quick Hitch Attachments Stainless Steel - comes without bolts

#10111 **\$27/pr**



Glasses

Clear or Tinted

#08200 **\$14**



Arms can be adjusted for length and tilt

Saddle Accessories

- A** Top Strap #6575 **\$28**
Bottom Strap #6576 **\$27**
- B** Head Pole Strap #6577 **\$3.25**
- C** Terrets #78907 **\$3**
- D** Rein Hook (water hook) #26135 **\$2.75**
- E** Couplers with Nylon #6475 **\$50**



Synthetic Crupper Towels

Longer lasting! Easy to clean

With Velcro

#6589 **\$18**

With Snaps
Better Coverage

#6530 **\$21**

In stock:
Black, Maroon, Red
and Dark Royal Blue.
Other colors available
by special request.



Girths

X-Wide Shaped

- padded with elastic

#6535 **\$85**



5-1/2" wide

Neoprene with elastic (our standard race girth)

#6536 **\$55**



**TOP
SELLER**

All elastic girth with Neoprene ends

#6538 **\$51**



Padded girth

#6533 **\$71**



3" wide

Cruppers

Standard Crupper

#6586 **\$34**

All colors in stock

Crupper w/Buckle

#6585 **\$47**

Designed for ease of use

Padded Crupper

#6587 **\$43**

Replacement Cushion for Padded Crupper

#4204 **\$12.50**

Stiff Tail Crupper

#6568 **\$57**

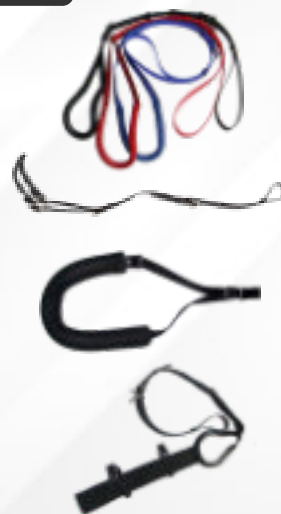

LINES

Includes handholds unless otherwise noted

Lines with Single Handholds

3/4" fronts, 1" backs
#6557 **\$78 ea**

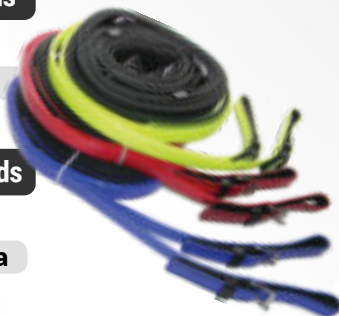

Lines with Double Handholds

3/4" fronts, 1" backs
#6553 **\$88 ea**

Regular style color fronts with black parts in hand, or all color

Lines with Single Handholds

5/8" fronts, 1" backs, with reinforced front
#6564 **\$122 ea**



European Style Lines

14.5' long - all 3/4"
#6558 **\$93 ea**

5 loops on handholds, no swivel - open ends.
Black only



Lines with Single Handholds 3/4"

3/4" fronts & backs
#6555 **\$72 ea**

Black in stock.
Color is special order



Lines with Double Handholds 3/4"

3/4" fronts & backs
#6552 **\$92 ea**

Black in stock. Color is special order

Training Lines

#6635 **\$53**

3/4" lines without handholds, snaps sewn in to the end, no swivel - open ends.



**ALL LINES AVAILABLE IN ALL COLOR UPON REQUEST.
ALL LINES ARE 13.5', EXCEPT FOR #6558 WHICH IS 14.5'**

Line Accessories

Single Handholds

3/4"#6549 **\$15.50 per pr**
1"#6548 **\$20.00 per pr**

Double Handholds

3/4"#6551 **\$30 per pr**
1"#6550 **\$39 per pr**

In stock: **1" Black**
Colors are special order

In stock: **Black.**
Colors are special order



Cavesons

Race Halter (Caveson)

#6518 **\$26**

Caveson w/Flash Nose Band

#6519 **\$33**



1 size fits most - Soft lining on inside
All colors with black lining are in stock
With colored lining: Special Order

Swivel

Line Swivel
#6560 **\$11.50**



Black only

BRIDLES

Open Bridle #6502 **\$92**

Specify color. Available in solid color or black with color.

Open Cheeks Only #6516 **\$20/pr**

Black in stock



Kan't C Back Vinyls

All Vinyl #17512 **\$49/pr**

Two-Toned Vinyl #17513 **\$59/pr**

(special order)

Solid colored Open Bridles In Stock

#6502

#17512

#17513

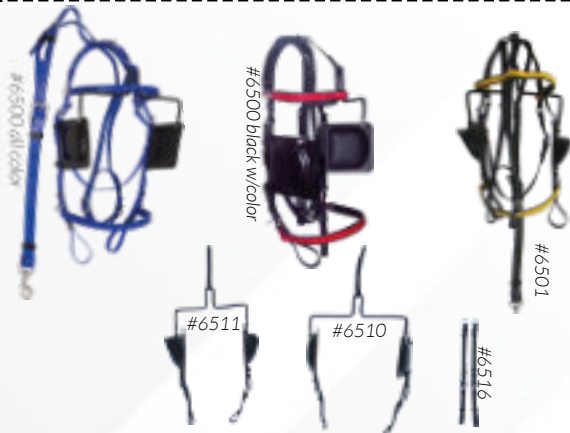

Kan't C Back Bridle #6501 **\$104**

Available in solid color or black with color.

Kan't C Backs only #6511 **\$37**

Blind Bridle #6500 **\$112**

Available in solid color or black with color.

Blinds only #6510 **\$40**

Open Cheeks #6516 **\$20**

Bridles - Convertible

Convertible Bridle

Open Cheek to Blind #6401 **\$112**

Convertible Bridle

Open Cheek to Kan't C Back #6402 **\$108**

Open Cheeks with Snaps #6406 **\$23**

Blinds Only with Snaps #6407 **\$22**

Kan't C Backs Only with Snaps #6408 **\$18.⁵⁰**



#6401

Bridles - Snap-On Murphys

Blind Bridle with Snap-On Murphys #6498 **\$128**

Kan't C Back Bridle with Snap-On Murphys #6494 **\$124**

Blinds Only with Snap-On Murphys #6497 **\$61**

Kan't C Backs Only with Snap-On Murphys #6495 **\$58**

Replacement Murphys with Snaps (specify for Blinds or Kan't C Backs) #6509 **\$21/pr**



#6509

#6498

BRIDLE PARTS & ACCESSORIES

Crowns

Fit any of our bridles

Straight Crown

Bio straps lined with soft foam on inside

#6520 **\$18.50**

Black in stock. Color: **special order**

Shaped Crown

Bio straps lined with soft foam on inside

#6521 **\$29**

Black only

Straight Crown with Protector

Bio straps lined with soft foam on inside plus an additional protective piece.

#6523 **\$25**

Black only

Shaped Crown with Protector

Bio straps lined with soft foam on inside plus an additional protective piece.

#6525 **\$33**

Black only

Front Overcheck #6522 **\$17**

Rear Overcheck #6528 **\$22**

Humane Overcheck/Chin #6531 **\$15.50**



Throatlatch #6532 **\$7**

Black in stock. Color: **special order.**

Noseband

#6526 **\$6**

Browband

#6517 **\$6.50**

Embroidered Brow

#6434 **\$40**

For on Bridles

Embroidered Brow w/snaps

#6435 **\$46** (not shown)

For on Halters

Embroidered Nose

#6437 **\$36**

For on Bridles

Please specify color and name plus embroidery color.
Embroidered items may take 1 week for processing.

Brow with snaps

#6410 **\$10.50**

To snap onto your halters.
Please specify color when ordering.
Available in custom widths

Tie Downs

Bungee Tiedown - Reg or XL sizes

#6582 **\$14**

Bio Tiedown

#6584 (short) **\$17.50**

#6583 (long) **\$18.50**

Tiedown w/Rubber Ring

#6579 **\$24**



Shadow Roll 3" diameter

Solid Color, large, all fur #92820 **\$45**

Large 2-toned, all fur #92831 **\$79**



Black in stock.
Other colors
available by
special request.

BRIDLE PARTS & ACCESSORIES

Murphy Blinds

All Synthetic - no oiling!
With reinforced stitching.

Regular size

#6512 \$34

Small size

#6514 \$32

Regular size w/Popout

#6513 \$40

Small size w/Popout

#6515 \$37

Black in stock. Color: special order

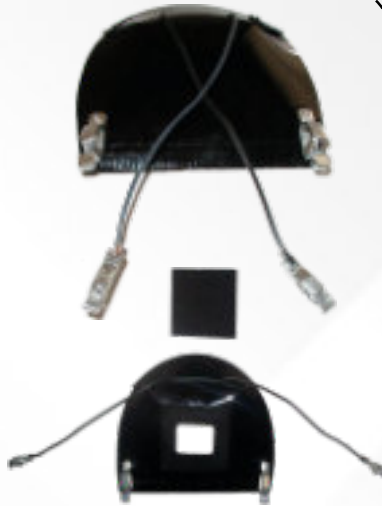

Earplugs

Ear Plugs

#10543
\$18

Ear Plugs w/Hood

#10541
\$36

Rosettes

#28011 \$5.⁵⁰



Breast Collars

Nylon Personalized Breast Collar with Padding

#6451 \$54

- 3+SAVE 10%
- 6+SAVE 15%
- 10+SAVE 20%

Maximum 20 letters

(40 can be done for additional cost)



Custom Order

Supreme Personalized Breast Collar

#6633 \$60

- 3+SAVE 10%
- 6+SAVE 15%
- 10+SAVE 20%

Custom Order



#6544 \$48

Made extra heavy especially for jogging (shown with pad)
Price does not include pad

Jogging Breast Collar Pad, Vinyl with Neoprene 4" x 38"

#17565 \$28

Jogging Breast Collar Pad with stripes 4" x 38"

#17525 \$47



Buxton Covers

Fur Covers

#17555 \$43

Fur Covers

2-tone (custom)
#17557 \$76

4 Piece Sets

(2) 2" x 17", (2) 2" x 12".

Covers slide unto the Buxtons

Custom Order

#6545 Average \$45

#6546 Padded \$53





Nylon
#6539 **\$32**

3/4" nylon - all color
Black, Royal Blue, Red, Green,
Maroon, Purple, Brown, Silver,
Yellow, Orange, Pink, Neon Green

**Nylon Buxton with
Neoprene Padding**

#6440 **\$44**

**3/4" Nylon with 1-1/4"
Neoprene Padding**
Any color with Black Neoprene

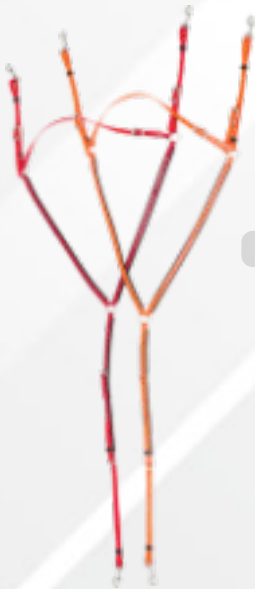

Beta
**3/4" Beta with 1/2"
Bio Overlay**
#6541 **\$53**

In stock with 3/4"
Black with 1/2" Color

**Biothane® with
1" Neoprene Padding**
#6543 **\$63**



**Personalized Nylon
Buxton with
Neoprene Padding**

#6441 **\$83**

3+SAVE 10%
6+SAVE 15%
10+SAVE 20%

Available in any color

Custom Order

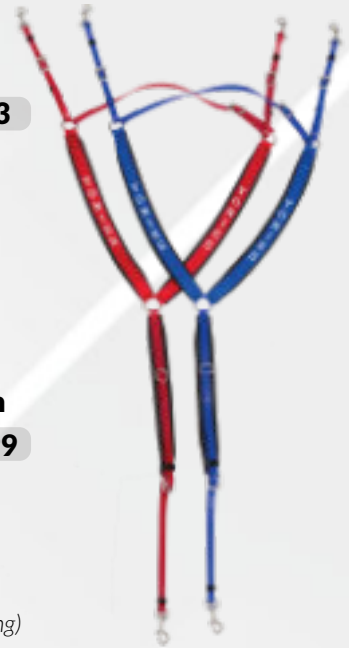

**Supreme
Personalized Buxton**

#6442 **\$99**

3+SAVE 10%
6+SAVE 15%
10+SAVE 20%

Same as nylon but with
Biothane straps (longer lasting)

Custom Order



Brown's Buxton

#6630 **\$75**

An extra wide
padded Buxton

Custom Order

Knee Spreader

#6665 - single **\$150**
#6666 - double **\$220**
#6667 - add-on to buxton **\$72**

Is your horse a "knee knocker"?

Buxton style knee spreader helps to widen the horse's gait so they don't hit their knees as hard. One strap goes on each side of neck, bottom piece goes between the legs and fastens to the shafts or up to the harness.

- Can be used on either side
- Easy to put on and easy to adjust
- Rubber ring for comfort
- Adjust for your horse's needs.
Not every horse will have the same results.



PADS

All pads 6" x 37"

- A** Vinyl/Neoprene, closed cell foam #17524 **\$35**
- B** Vinyl/Neoprene w/stripes, closed cell foam #17540 **\$54**
- C** All Neoprene, closed cell foam #6565 **\$51**
- D** Vinyl/Neoprene w/colored edge, closed cell foam #17541 **\$49**
- E** Add an extra bead/piping of color for your pad! **\$35/pad extra**

Black with Color are usually in stock, allow extra lead time for other colors.

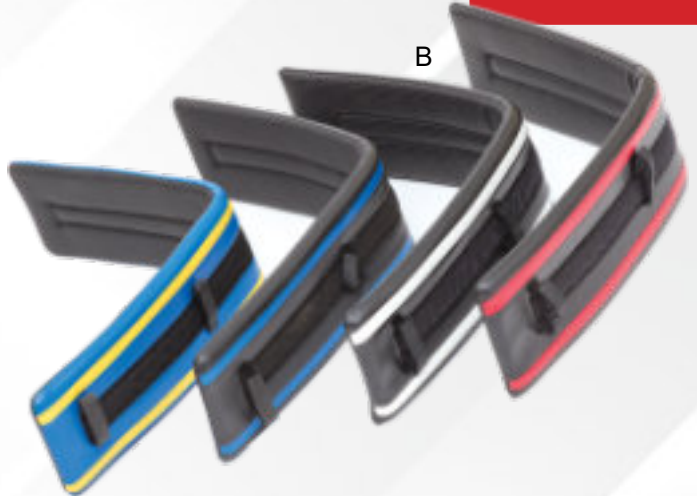

Neoprene (bottom side)

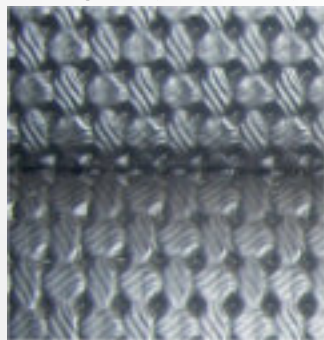

NEED LINIMENTS?

LIMP TO PAGES 63 & 64

VINYL COLOR OPTIONS



RACE

Hopples

Super Glide Hopples with Super Strong Hangers

Sizes: Horse: 50" - 62", XL: 54" to 66",
Pony: 39" - 45", Mini: 31" - 38"

Loops (inside measurement) Horse - **17"**, Pony - **12"**, Mini - **8"**

Available in all Black or in any of our Harness Colors.
Allow 2 weeks for Mini and Pony sizes



Light Weight, Special Order	#6606	WHD	\$212
Medium Weight, w/Black Loops	#6609		\$206
Heavy Weight w/Heavy Loops, w/Clear Loops	#6624*	WHD	\$202
Heavy Weight, 1-1/2" wide Beta	#6620		\$224
Trotting Hopples to the Bike	#6618		\$265

Accessories

Center Straps, Regular Black	#6590	\$31
Center Straps, Regular Color	#6591	\$31

*Heavy weight hopples #6624 and #6620 have a 1 year guarantee against defects in workmanship and materials. Must have a copy of invoice with hopples to prove how old they are. All other hopples are not guaranteed against cracking.

Hopple Hangars

Ends and holes are heat sealed for a longer lasting hanger! Our black hanger will out last any other hanger on the market!



Riding Hobbles

Add for Riding	\$12.50
Add Ring	\$1
Add Crupper/Gruppa	\$35
Add Gruppa Straps only	\$19

Regular, Black	#6594	\$62
Regular, Color	#6595	\$63
X-Large, Black	#6596	\$67
X-Large, Color	#6597	\$67

Chicago Style Hangers

Black	#6598	\$73
-------	-------	------

WHIPS



Handmade

These are the flex whips that everyone likes

Whip Colors: **Natural, Black, Red, Blue, Green, Yellow, Orange, Pink and Purple**

We can make 2-toned whips for you in any combination. Minimum order of 10 pieces.



Driving

36" Running Aces #11233 **\$22 ea**

48" #11235 **\$22 ea**
10+ pcs **10% OFF!**



Training

60" #11236* **\$29 ea**
10+ pcs **10% OFF!**

72" #11258* **\$31 ea**
10+ pcs **10% OFF!**

ASK FOR AVAILABLE COLORS FOR 72" WHIPS

*Extra long shipping charge applies

Poppers Only - 12" overall

Any color #11260 **\$2.25 ea**

Stock: **Black, Blue, Green, Red**

"These whips last 3 times longer than others!"
Jonathan Roberts

"The best whip ever made."
Walter Haynes

Head Poles & Accessories

A	Chin Burr with Regular Burrs	#6482	\$11.50
	Chin Burr with Nipped Burrs	#6484	\$11.50
B	Roller Burr, Long Style with 1/2" Burrs (7" Burrs w/15" velcro)	#6470	\$36
	Roller Burr, Long Style with 3/4" Burrs	#6472	\$36
C	Roller Burr, Short Style with 1/2" Burrs (7" Burrs w/7" velcro)	#6474	\$37
	Roller Burr, Long Style with 3/4" Burrs	#6473	\$37
D	Roller Burr, Long Style with 1/2" Burrs w/Burrs all the way (15" Burrs w/15" velcro)	#6469	\$48
	Roller Burr, Long Style with 3/4" Burrs w/Burrs all the way	#6468	\$48

Made in the USA



Line Pole - 23" long

#45475 **\$50**

Head Pole - 36" long

#45479 **\$53**

Head Pole - 38" long

#45481 **\$53**

Head Pole - 42" long

#45482 **\$53**

Which bit do I need for my horse? We hear this question quite a bit, and there is no correct answer. It's about like trying on shoes, you need to try a few till you find one that works for you

We've rated the following bits and made a few suggestions, but it all comes down to what your horse likes

01. **GENTLE** known as a bit made for "comfort"
02. **AVERAGE** your average bit (snaffle, mullen, etc.)
03. **LEVERAGE** these bits are designed with lots of leverage points (Liverpools, Butterflies, etc.). Ask your trainer for help.
04. **SEVERE** for corrective action, use carefully
05. **VERY SEVERE** for heavy corrective action, use carefully
06. **CAUTION** you can cause lots of damage with this bit. Use sparingly



- A Plain or Smooth Cheek** - Mildest setting. The bit is pulled back and up into the mouth and the curb chain is not engaged.
- B Rough Cheek** - Allows slight curb action while the bit is pulled back in the mouth.
- C First Slot** - Provides moderate curb action as well as poll pressure
- D Second Slot or Middle Slot** - Gives increased leverage! Pulls the bit down in the mouth so that the tongue and lower jaw are pinched between the mouthpiece and the curb chain. Poll pressure is also created.
- E Third Slot or Bottom Slot** - Exerts maximum poll and curb pressure. This severe rein setting should be used only as a last resort in a crisis. It is also known as "Dead Man's Slot" because if you are in the bottom slot you have no where else to go! More training should be done.

NOTE: The tighter the curb chain, the less time your horse has to react. Loosening the chain will allow a longer response time. A well trained horse will feel the bit move before pressure is put on the chain (if chain is loose). A rule of thumb is to leave two fingers inside the chain when first adjusting, change as needed. DO NOT use a liverpool without a chain! One of the main concerns with starting a young horse is to make them want to seek the bit. Contact with the bit becomes their comfort zone. They are safe and know what to do as long as they have that contact. A severe bit destroys the relationship with the bit before it ever has a chance to get in the horse's mind. A driving horse must have a good relationship with the bit. Safe driving!

Liverpool Bit - Snaffle Mouth

Stainless Steel - Sides with Slots

4-1/2"	#25773	\$35
5"	#25775	\$35
5-1/2"	#25777	\$35
6"	#25778	\$35
6-1/2"	#25779	\$35

4-1/2" and 5" have 2 slots,
5-1/2" to 6-1/2" have 3 slots



Liverpool Bit - Straight Mouth

Stainless Steel - Sides with Round Holes
(round holes are for lines with snaps)

4-1/2"	#25754	\$45
5"	#25755	\$45
5-1/2"	#25756	\$45
6"	#25757	\$45
6-1/2"	#25758	\$45



Liverpool Bit - Straight Mouth

Stainless Steel - Sides with Slots

4-1/2"	#25763	\$29
5"	#25765	\$29
5-1/2"	#25767	\$30
6"	#25768	\$29
6-1/2"	#25769	\$29

4-1/2" and 5" have 2 slots,
5-1/2" to 6-1/2" have 3 slots



Liverpool Bit - Snaffle Mouth

5" Stainless Steel (not shown)
Stainless Steel - Sides with Round Holes

5"	#25780	\$36
5-1/2"	#25781	\$39

Liverpool Bit - Mullen Mouth

4-1/2" Stainless Steel		
Slotted Cheek	#25792	\$31
5" Stainless Steel	#25793	\$31
5-1/2" Stainless Steel	#25794	\$31

LIVERPOOL BITS ARE MARKED EITHER 2 OR 3
LOOPS/SLOTS.

IF INTERESTED IN OTHERS, PLEASE CALL



Butterfly Bit with Low Port

- 4-1/2" Stainless Steel #25239 **\$40**
- 5" Stainless Steel #25240 **\$40**
- 5-1/2" Stainless Steel #25242 **\$40**
- 6" Stainless Steel #25246 **\$40**
- 6-1/2" Stainless Steel #25248 **\$40**

WITH 2
LOOPS
PLUS RING



Butterfly French Link Snaffle Bit

w/Copper Link

- 5" Stainless Steel #25254 **\$33**
- 5-1/2" Stainless Steel #25256 **\$33**
- 6" Stainless Steel #25259 **\$33**
- 6-1/2" Stainless Steel #25261 **\$33**

WITH 2
LOOPS
PLUS RING



Butterfly Bit - Mullen Mouth

- 5" Stainless Steel #25268 **\$37**
- 5-1/2" Stainless Steel #25270 **\$37**
- 6" Stainless Steel #25275 **\$37**
- 6-1/2" Stainless Steel #25278 **\$37**

WITH 2
LOOPS
PLUS RING



Butterfly Snaffle Bit

- 4-1/2" Stainless Steel #25784 **\$37**
- 5" Stainless Steel #25785 **\$37**
- 5-1/2" Stainless Steel #25787 **\$37**
- 6" Stainless Steel #25788 **\$37**
- 6-1/2" Stainless Steel #25789 **\$37**

WITH 2
LOOPS
PLUS RING



Happy Mouth Bits

The Original!
Apple scented



Snaffle GENTLE

- 5" #59700 **\$45**
- 4-1/2" #59701 **\$45**

Mullen AVERAGE

- 5" #59708 **\$43**
- 4-1/2" #59709 **\$43**

Snaffle Bit AVERAGE

An old favorite, now with a safety bar.
Stainless steel.

5" has safety bar, other sizes do not

- 3-1/2" S/S #22237 **\$16.50**
- 3-1/2" Nickel #22236 **\$7.50**
- 3-3/4" S/S #25551 **\$18.50**
- 4" S/S #25552 **\$18.50**
- 4-1/4" S/S #25553 **\$18**
- 4-1/4" Nickel #25227 **\$10.50**
- 4-1/2" S/S #25554 **\$19.50**
- 4-3/4" S/S #25555 **\$18.50**
- 5" S/S #25556 **\$27**



TOP
SELLER

Half Cheek Snaffle Bit - Heavy

AVERAGE

- 5" Stainless Steel #25559 **\$28**
- 5-1/2" Stainless Steel #25560 **\$27**



Uxeter Kimberwick Snaffle Bit

Stainless Steel with 2-1/2" Dees

- 5" #25592 **\$41**



Rubber Bits with S/S Bar Inside

5" Snaffle GENTLE

- #38542-S **\$22.00**



5" Mullen GENTLE

- #52253-S **\$20.00**



6-Ring Norton Bit

CAUTION

Stainless steel

- 5" #25408 **\$30**

Often used with nose band #2145 (below)!



Noseband

For 6-Ring Norton Bit (above)



- #2145 **\$20**

Ring Snaffle Bit

AVERAGE

- 3-1/2" Nickel - Mini #22240 **\$4**
- 4-1/4" Nickel - Pony #22241 **\$9**
- 5" Nickel #25228 **\$10**
- 5" Stainless Steel #25238 **\$13**
- 6" Nickel #25561 **\$6**
- 6" Stainless Steel #47707 **\$13.50**



Half Cheek Mullen Mouth

AVERAGE

- 3-1/2" Nickel #22235 **\$11**
- 4-1/4" Nickel #25225 **\$13.50**
- 5" Stainless Steel-S #52252 **\$19.50**

3-1/2" and 4-1/4" do not have the safety bar.



Dr Bristol Bit

AVERAGE

5"
#38545
\$24



Stainless steel

Twisted Wire Snaffle Bit

5"
#25748-S
\$20

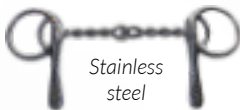

Stainless steel

Double Twisted Wire Snaffle Bit

VERY SEVERE Stainless steel

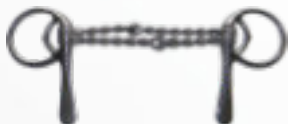

5" - #25750-S - \$20

Marble Bit

AVERAGE



5" - #25583 - \$23
6" - #25585 - \$24

Berry Bit

Stainless steel



5#25410 \$31

Beta Bit

GENTLE

A lot of people have good results using this bit on pullers, colts, and horses with tender mouths. Stainless steel rings.



5" - #6508 - \$22

Jic Bit

VERY SEVERE



Stainless steel

5" - #25400 - \$24

Mule Bit

6" Nickel Plated



#79001 \$15

Elbow Bit

#25538
6 1/2"
\$44



Pelham Snaffle Bit

3-1/2" Stainless Steel

#25580
\$49



Over Check Bit

Stainless Steel



3-1/2" - #25539 - \$8
4-1/2" - #25541 - \$8.50
4-3/4" - #25542 - \$7.50
5" - #25573 - \$7.50
6" - #25546 - \$8.50

Burch Bit

Stainless steel



5"#25547\$26

Over Check Bits - Show Style



6" Stainless Steel

#28300 \$11.50

Crit Davis Bit

Stainless steel
Use with
#2145 nose



5" - #59600 - \$16

McKeron Bit

Stainless steel



5" - #59520 - \$28

Bit Guards, Black

#25590
\$3.25/pr



Bit Wrap 3" x 36"

Temporarily out-of-stock.
Call before ordering.

#25588
\$? call



Adjustable Chin Strap

with Gullet Strap
Humane Overcheck

#6531 \$15.50

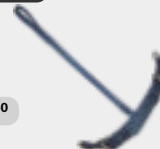

Curb Strap

#4183
\$13



Curb Chain

#25709 - 9" - \$5.00
#25710 - 11" - \$5.50

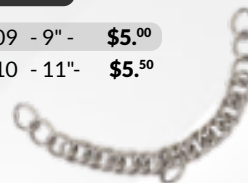

Curb Hooks

#25700
\$2.50/pr



Lolling Bit

For the horse that sticks out his tongue

5" - #79002 - \$56



NEED A CERTAIN BIT?
GIVE US A CALL,
WE MAY BE ABLE TO
GET THEM FOR YOU!



Bitless Bridle Kit - Driving Model

For a horse that doesn't like a bit in the mouth. If you go to hitch up and the horse is chomping angrily on the bit with saliva going all over the place, then I would try this!

Designed by Dr. Robert Cook, these bitless kits get used with your existing bridle.

Basic instruction manual is included.

#21275

\$64

WE ALSO RENT THESE OUT FOR A "TRIAL" RUN - \$12/MONTH
(ADDITIONAL \$10 CLEANING FEE IF NOT RETURNED CLEAN)



*Riding Model Shown

BOWMAN BITS USA

MANUFACTURING COMPANY

BY HORSEMEN, FOR HORSEMEN

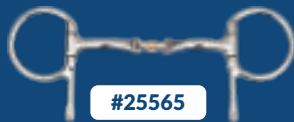

#25565

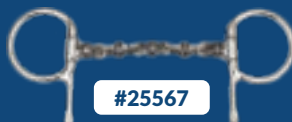

#25567



#25569



#25566



#25570



#25578

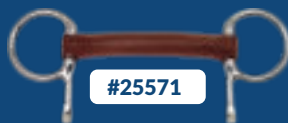

#25571



#25572

ITEM #	DESCRIPTION	PRICE	
#25565	3-Piece Snaffle	\$88	AVERAGE
#25566	Low Barrel Roller, Comfort Snaffle	\$87	AVERAGE
#25567	Waterford, 5" Bowman	\$89	AVERAGE
#25570	Smooth, 4-ring, 5"	\$89	SEVERE
#25569	Twisted, 4-ring, 5"	\$83	VERY SEVERE
#25571	Leather Flex	\$128	GENTLE
#25572	Leather Broken	\$128	GENTLE
#25578	Mohawk Overcheck w/loose rings, SS 5"	\$38	GENTLE

FOR ANY OTHER BOWMAN BIT, JUST ASK. WE CAN HAVE IT SHIPPED DIRECTLY TO YOU.



Padded Harness

The best harness for show and marathon! The saddle is a one piece with rolled padding the full length of the saddle and with a wide gullet opening at the top. The saddle has a firm tree in it. Closed shaft loops are standard. Breast Collars are average V-shaped with rounded ends. Girths have rolled padding and buckle wear plates. Traces are slotted and have wear plates at the holes in the front.

Included is a false martingale with a teardrop. No bits or side checks unless requested. Bridle blinds come in a dull matte finish and are round with a deep shaped cup. Mini Blinds are a standard with a patent finish.

Strap sizes will vary with the size of harness. Draft size harness comes with a ring in the turnback and 1" neck and hip and 1-1/2" tug bearers. For more details please ask your sales rep. Hames Harnesses: Show Hames are an upgrade.

Harnesses with brass hardware, all russet, or neoprene padding: allow additional time to manufacture.

For Russet or Brass on any Harness, add 20%.

	DRAFT	XLARGE, HORSE, COB	PONY	MINI
Single w/Buckle in Breast Collar#4145 each	\$1445	\$1310	\$1130	\$975
Single w/Stainless Steel Hames and Short Tug#4146 each	\$1415	\$1330	\$1125	\$970
Pair w/Short Tug Breast Collars#4147 pair	\$3095	\$2770	\$2380	\$2070
Pair w/Long Tug Breast Collars#4148 pair	\$3195	\$2820	\$2550	\$2130
Pair w/Stainless Steel Hames and Short Tug#4149 pair	\$2920	\$2695	\$2320	\$1870
Pair w/Stainless Steel Hames and Long Tug#4150 pair	\$2970	\$2720	\$2310	\$2040
4 In Hand w/Long Tug Breast Collars#4151 pair	\$5980	\$5430	\$4770	\$4095
4 In Hand w/Stainless Steel Hames and Long Tug#4152 pair	\$5595	\$5210	\$4390	\$3950

Notice: Handmade Biothane Keepers are now standard on all harnesses. No more cracked Keepers!



**ORDER FORM
STARTING ON
PAGE 39**

WHY SHOULD I BUY THIS HARNESS?



- ✓ Easy to Clean, just use soap and water!
- ✓ Lightweight
- ✓ It's Comfortable
- ✓ Very Durable
- ✓ All Stainless Steel Hardware
- ✓ Custom Made to your Specifications!



Linda Roger Reserve Champion with Bravo at the 2019 Lorenzo Driving Competition



Pics of you, Margaret Shenker



Note: All of our show chain is sewed on by hand

Padded Model

Recommended for anyone interested in the comfort of the horse

Advanced/Competition Level Harness

Pleasure Model

Recommended for Beginners/Entry Level Harness
Basic Harness



Pleasure Harness

These harnesses are great for all occasions including some shows. All padded areas come with rolled edges such as the breast collar, breeching, belly band, hip strap and neck strap. Standard saddle comes with a stainless steel tree inside. Closed shaft loops are standard. The breast collars are straight across the front. Slotted traces are standard. The bridle comes without the bit and side check unless requested. The bridle blinds are dull matte finish and are round with a deep shaped cup. The bridle has a teardrop. False martingale with teardrop is an option on single harness, but is included on pair harnesses.

For Russet or Brass on any Harness, add 20%.

WARMBLOOD, HORSE AND COB PLEASURE HARNESS

	XLARGE, HORSE, COB	PONY	MINI
Single with Continuous Breast Collar - #4101 - each	\$990	\$735	\$590
Single with Buckle in Breast Collar - #4102 - each	\$1065	\$795	\$655
Single with Stainless Steel Hames with Continuous Trace - #4103 - each	\$1060	\$795	\$650
Single with Stainless Hames, Short Tug - #4104 - each	\$1130	\$865	\$755
Pair with Continuous Breast Collars - #4105 - pair	\$2240	\$1660	\$1355
Pair with Short Tug Breast Collars - #4106 - pair	\$2395	\$1820	\$1510
Pair with Long Tug Breast Collars - #4107 - pair	\$2470	\$1930	\$1580
Pair with Stainless Hames, No Buckle - #4108 - pair	\$2250	\$1710	\$1390
Pair with Stainless Hames, Short Tug - #4109 - pair	\$2430	\$1780	\$1550
Pair with Stainless Hames, Long Tug - #4110 - pair	\$2450	\$1895	\$1590
4-Up with Long Tug Breast Collar - #4111 - 4up	\$4750	\$3740	\$3160
4-Up with Stainless Steel Hames, Long Tug - #4112 - 4up	\$4695	\$3670	\$3150



Mini Economy

This mini harness is an inexpensive lightweight harness. All padding such as crown, breast collar, breeching, belly band, hip strap and neck strap are lined with a soft lining. Hardware is stainless steel or solid brass. Saddle is flexible and has no tree. Teardrops are optional. Breast collars are straight across the front with continuous traces. Snaffle Bit and side checks are included. Bridle blinds come in a patent finish and are round shaped. False Martingale is an option on single harness, but is included with pair harness.

For Russet or Brass on any Harness, add 20%

	MINI
Single Breast Collar Style#3191	\$555 ea
Single with Black Hames#3197	\$585 ea
Single with SS Hames#3198	\$620 ea
Pair Breast Collars with Continuous Traces#3687	\$1255 pr
Pair Harness with Black Hames and Continuous Traces #3698	\$1250 pr
Pair Harness with Black Hames w/Balls and Continuous Traces #3699	\$1280 pr
Pair Harness with SS Hames #3195	\$1325 pr

Bio Thane Harness Order Form

435 Churchtown Road, Honey Brook, PA 19344



610-273-7370



412-504-6014



sales@yonies.com

WWW.YONIES.COM

Measuring Chart for: Beta Biothane Harnesses

Name _____

Farm _____

Address _____

Home phone _____

Cell phone _____

Fax _____

Email _____

When measuring your horse for a harness, it is easier to use a piece of string or rope to obtain the dimension and then measure that string with your tape measure. If using a tape measure it is best to use a soft tape measure for best results. Measure each area twice to make sure you are correct.

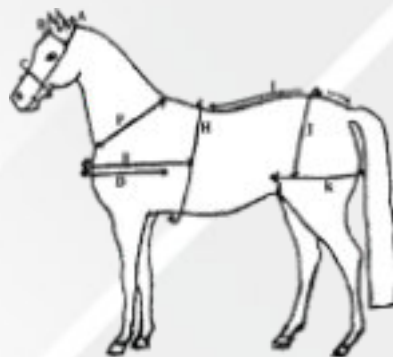

Name of Horse/Pony _____

Breed _____ Height _____

PLEASURE DRIVING

- A Poll:** Measuring from the corner of mouth over the poll back to the corner of mouth on the other side. _____
- B Browband:** We measure our browbands from tip to tip. The best way to do this is to have a 1" wide halter on your horse, have the halter back a 3/4" from the ear. Now take your measurement including the halter on each side. _____
- C Noseband:** Position your tape measure or string 1 to 1.5 inches below the cheekbone and measure all the way around the nose. _____
- D Breastplate for Single:** Measuring from the back side of the shoulder (elbow area) across the chest to the back side of the elbow area (or 3 inches in front of saddle skirt). _____
- E Breastplate for Pair:** The best way to get this measurement is to put a saddle and bellyband on the horse, and then measure from the center of the saddle around the front of the horse, to the center of the saddle. _____
- F Full collar, if applicable:** Length _____ Width _____
- G Traces:** Slot end _____ Dee end _____ Overall Length _____
- H Girth where saddle sits:** Position the tape behind the wither and measure all the way around the girth (Staying about 3" behind the elbow of the horses shoulder). _____
- I Turnback:** Here it works best to have a saddle on your horse. If you measure without the saddle it may not be as accurate. Your measurement should be from the back of the saddle to the base of the tail. _____
- J Hip Strap:** Measuring from the top of the breeching across the rump to the top of the breeching _____
- K Breeching:** Measuring from the flank Line around the back of the horse to the flank Line on the other side. Dees should come front past the flank line about 1inch. (See above Drawing) _____

Overall measurement from tip to tip is what we use



Add 11-1/2" to working hole to working hole measurement for overall length

Overall measurement from tip to tip is what we use



Add to Working hole to working hole measurement for overall length
1-1/2" traces add 14-1/2", 1" traces add 13-1/2"

OPTIONAL ADVANCED ORDER FORM STARTING ON THE NEXT PAGE

NEW HARNESS ORDER FORM FOR OUR PADDED MARATHON HARNESS

Yonie's Harness Shop

435 Churchtown Rd.
Honey Brook, Pa. 17344

☎ 610-273-7370

☎ 412-504-6014

✉ sales@yonies.com

🌐 www.carriagedriving.yonies.com

Date Ordered ____/____/____

Name _____

Name if drop shipping _____

Address _____

Phone _____

Email _____

Harness Type: Single Pair Tandem 4-in-Hand

Harness Color : Black 2-Tone Russet+20% Patent+20%

Hardware: Stainless Steel Brass+20% Russet w/Brass+20%

Do you have a show coming up soon that you would like to use your new Harness? If so, what date would you need your Harness by? _____ Please realize that at times we are busier than other times and might not always be able to be on time but we are willing to try!

Crown - Straight without Ring is Standard

Options:

- Shaped
- Padded Shaped
- With Ring for side check or Roger Rings to go tandem



Rosettes Plain - Standard

Options:

- Rope Edge Wheat Edge
- Heart Shaped Texas Star



Brow Band - Rolled is Standard

Options:

- Show Chain
- Fill in item # _____



Teardrop - Plain is Standard

Options:

- Patent Look - on teardrop
- Any ornament installed see Catalog for item # _____



SEE PAGE 14 FOR MORE OPTIONS AND PRICES

Blinds w/Winker

Deep Dull is Standard except for Mini Size which has a Patent Finish

- Options:** Patent Look KCB Blinds Open Cheeks

Any ornament installed (see above) See Catalog for item # _____



Nose Band - Single Buckle Style Rolled is Standard

Options:

- Double Buckle Style w/o gullet
- Double Buckle Noseband Back Style w/Sewed-in Gullet w/o Ring
- Double Buckle Noseband Back Style w/Sewed-in Gullet w/Ring



Single Buckle Noseband
is our Standard
#4118



Double Buckle
Noseband Front
#5020



Double Buckle Nose
w/o Gullet
#5023



Double Buckle Nose
w/Sewed-in Gullet w/Ring
#5031

Gullet Strap: Gullet Straps are not included in our Standard Harness Package

Options:

- Gullet Strap that slips over Throat Latch and Noseband
- Double Buckle Nose Back w/Gullet Strap Sewn In
- Would you like a ring in your Gullet Strap to snap your lead into?



Gullet Strap that slips over the
Throat Latch and the Noseband

Check - Standard is without a Sidecheck or Overcheck

Options:

- Sidecheck
- Overcheck



Sidecheck
#4017

Breast Collar - Average V is Standard on all Padded Harness

Options:

- Super V
- Buggy Hames
- w/Patent Look
- w/Loose Terret on Hames
- Special Super V
- w/Fixed Terret on Hames
- Show Hames



Ave V -- standard on all
padded harness
#4123



Super V
with adaptable line of draft
#4160



Stainless
Steel
w/Swivel
Terrets



Super V with
ends turned down



Special V
#4165

Neck Strap #4080

Fixed Terrets is standard on Harnesses

Options:

- With Nylon Loop & Dees for Pair #4081
- With Floppy Terrets #4127
- With Sliding Terrets #4209
- With Adjustable Terrets #4218
- With Conway Terrets #51123

With Sliding
Terrets



With Conway
Terrets



Fixed Terrets
(Standard)



With Floppy
Terrets

With Adjustable
Terrets



With Nylon
Loop and Dee

Traces - Wears at Holes and 2 Slots at Back is Standard #413

Options:

- Dee End w/Tab #4137
- Roller Bolt Style
- Without Wears at Holes #4096



With Wear Plate is Standard on Harness



Dee w/Tab 3-Way



Slot End is Standard on all Harnesses



Without Wears at Holes

False Martingale with Tear Drop - Standard on all Padded Harnesses

Options:

- Patent Look on Teardrop
- Ornament - *For photos canter to page 14*



Saddle #4131

Options:

- Sliding Back Band Saddle #4138
- Road Plus Saddle #4177
- Patent on Long Punchout
- Patent on Short Punchout



Our Standard Padded Saddle that goes with our Padded Harness



Road Plus Saddle

Not Available in Draft Size

Shaft Loops - Closed is Standard #4133

Options:

- QR Style #4240
- French Tugs #4242
- Marathon Wraps #4245
- Closed without Billet to go with Wrap Strap #4243



Closed Shaftloop

Marathon Wraps



QR Style



French Tugs



Closed without Billets to go with Wrap Strap



Girths - Belly Band - Padded #4120

Options:

- Elastic w/Wears #4029
- Elastic w/o Wears
- Wrap Strap on Bellyband to go around Shafts #4244

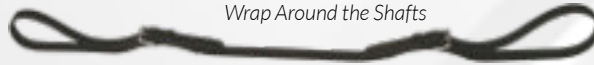

Wrap Strap to go on the Girth and Wrap Around the Shafts



Padded Belly Band Standard on our Padded Harness



Elastic w/Wears



Elastic w/o Wears

Turn Backs #4099

Options:

- QR Style #4298
- with Panic Snap #10025



This Snap is great for a quick release for on your Turn Back



QR Turn Back



Our Standard Turn Back

Hip Strap w/Dees is Standard on all Harnesses



Breechings w/Double Uptugs is Standard



Hold Backs

Options:

- With Trigger Snaps



Cruppers - Synthetic is Standard on all Harness #4045

Options:

- Leather #82169
- Fat Leather #82168
- Foam on Synthetic Crupper #4204



Leather



Synthetic Crupper is Standard on our Harness



Foam on Synthetic Crupper

Lines, All Brown - Beta w/Buckle in Hand is Average

Options:

- Swivel instead of Buckle in Hand #4072
- With Pinky Loop #4069
- With Stops #4064
- With Rubber Gripper Webbing #4326
- With Bumpy Rein Grip #4073
- With Smooth Rein Grip #4320
- With Braids #4066
- With Lace #4065
- With Cotton #4068
- With Leather #4337
- All Leather Lines #4330

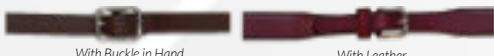

With Buckle in Hand, Standard on all Harness

With Leather

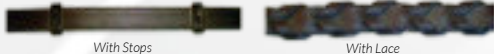

With Stops

With Lace

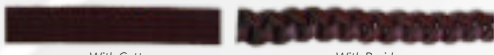

With Cotton

With Braids



With Smooth Rein Grip

With Rubber Gripper Webbing

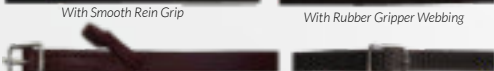

With Pinky Loop

With Bumpy Rein Grip



Swivel instead of Buckle in Hand

Color Trim Inlay - 15 colors to choose from

Options:

- Brow
- Nose
- Breast Collar
- Saddle
- Breeching



VISIT OUR WEBSITE AT: WWW.CARRIAGEDRIVING.YONIES.COM
PLEASE CALL IF QUESTIONS OR TO DISCUSS OPTIONS

THE A.D.S. HAS COME OUT WITH SOME INTERESTING VIDEOS THAT WE THINK EVERYONE WOULD ENJOY

Harness Fit & Adjustment by ADS:

https://www.youtube.com/watch?v=8t4KagTs0Es&feature=youtu.be&fbclid=IwAR1TnxbV5NUclVOz8-oPnpC0_Wx5PSkiFq9thhYBXcTIj96D36gj8xVRqYk

How to put on a single Marathon Harness by ADS:

<https://www.youtube.com/watch?v=u-l0EpGhVPw>

Difference between Yonies Pleasure and Padded harnesses:

<https://www.youtube.com/watch?v=HoUmn5jlv3Y&t>

Showing padded harness:

<https://www.youtube.com/watch?v=y4GiLIRoE0k&t>

Showing the reinforcement on the breastcollars:

<https://www.youtube.com/watch?v=-dMoGROuiVg>

TO VIEW ALL THE ABOVE LINKS PLEASE GO TO

WWW.CDE.YONIES.COM

AND CLICK ON THE LINKS FOR MORE INFO TAB AND SELECT THE VIDEO'S THAT YOU WOULD LIKE TO VIEW

FOR MORE DRAWINGS & INFORMATION, GO TO FORMS.YONIES.COM



I saw this handsome horse and every bit of common sense left my body and I bought him....

PLEASURE DRIVING

Bridles

DR=DRAFT HO=XLARGE, HORSE OR COB PO=PONY MI=MINI

Padded #4114	DR \$275	HO \$260	PO \$242	MI \$200
Pleasure #4100	DR \$250	HO \$246	PO \$224	MI \$184
Mini Economy #3190	\$204			

FOR BITS GALLOP TO PAGES 32-35



Bridle Parts



Straight Crown With Ring — to use with Side Checks - #4008

DR \$35 HO \$34 PO \$31 MI \$30

Pony and Mini w/#12 buckle

Straight Crown Without Ring - #4007

DR \$35 HO \$34 PO \$30 MI \$30

Mini Economy without loops #4006 \$20

FOR ROSETTES,
GIDDY-UP TO PAGE 14



Crown - Shaped Without Rings for Side Checks - #4010

HO \$50 PO \$42 MI \$41

Crown - Shaped With Rings for Side Checks - #4009

HO \$49 PO \$42 MI \$42

SIZES: DR, XL, HO, CO, PO, MA



Crown - Padded Shaped Without Ring for Side Checks - #4730

XL,HO,CO \$81 PO \$75 MI \$73

Crown - Padded Shaped With Ring for Side Checks - #4731

XL,HO,CO \$81 PO \$75 MI \$73

SIZES: DR, XL, HO, CO, PO, MA

Teardrop - #4019

HO \$9.50 PO/MI \$9



Throat Latch

#4022

DR \$13 HO \$12.50 PO \$10.50 MI \$9.50

Pony and Mini with #12 buckle

Pony & Mini w/#121 buckle - #4023 \$9

Gullet Strap

To connect your throat latch to your nose band to help keep your bridle on! Also includes a ring to snap your lead on to

#4193 HO \$11.50 PO \$10.50 MI \$10.50



Blinds With Winker

Deep Blinds With a Matte Finish. Leather Blinds with Biothane Straps. Patent Finish available for an **additional 20%**



Mini size is in a synthetic patent as a standard.

For matte finish on a Mini, there is an **additional fee of \$25**

#4002 HO \$194 PO \$182 MI \$132

Hanger Straps



#4012 \$11.50 pr

Blinds Kan't C Back Style With Winker

#3998 Horse, Cob and Pony \$260



This price is Blinds & Winker only, Not a Complete Bridle.

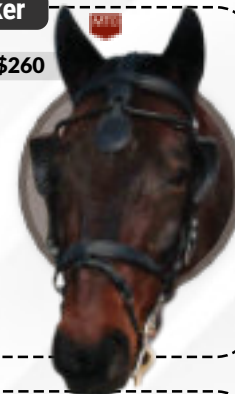

Open Cheeks



#4185 (per pair)

HO \$43 PO \$38 MI \$32

Side Check with Gag Runners

#4017

HO \$86 PO \$63 MI \$60

Mini Pleasure Style w/o Gag Runners
Goes through loops in the crown

#3113 \$31

#4018 Sidecheck - Chain Style

HO \$136



BROW BANDS

DR=DRAFT HO=XLARGE, HORSE, OR COB PO=PONY MI=MINI

Pleasure Brow Bands



With Black and Brown Trim only.
Lined with a soft Beta material.
#4005
Use #4004 for colored trim.

HO	\$20
PO	\$19. ⁵⁰
MI	\$18. ⁵⁰

**WALK TO PAGE 5 FOR
BETA COLOR OPTIONS**

**BROW BAND WITH COLOR PADDING +20%
NO CUSTOM FEE IF BUYING 3 OR MORE IDENTICAL PIECES**

Rolled Padding

#4115 (each)

HO	\$32
PO	\$31
MI	\$28



With Rhinestone Spots
Specify large or small crystals
#4095 (each)

HO (lg crystals)	\$65
HO (sm crystals)	\$75



CALL FOR PRICING ON OTHER SIZES

With Weaver Chain
#4116 (each)

HO	\$74
PO	\$71
MI	\$68



With Nickel Plated Ring Style Show Chain
#4142 (each)

HO	\$116
PO	\$114
MI	\$112

**NOW ALSO AVAILABLE
IN BRASS +20%**



Crystal Colors



With Round Spots

#4305	\$53
-------	------



With Hex Spots

#4113	\$55
-------	------

With Pyramid Chain (#C99)
#4143 (each)

HO	\$85
PO	\$80
MI	\$77



**NOW ALSO AVAILABLE
IN BRASS +20%**

With Canada Chain (#H355)
#4144 (each)

HO	\$78
PO	\$71
MI	\$68



**NOW ALSO AVAILABLE
IN BRASS +20%**

With Lacing
#4303 (each)

HO	\$96
PO	\$96
MI	\$96

*Hand Braided Lacing
(takes a lot of time!)*



NOSE BANDS

All are available in Black or Two-Toned

SINGLE BUCKLE NOSE BANDS PADDED STYLE

#4118

HO \$34 PO \$33 MI \$30



DOUBLE BUCKLE NOSE BANDS PADDED

Front Part - #5020
XL,HO,CO \$28

Back Part - XL, Horse, or Cob
#5023 \$28



OTHER SIZES ALSO AVAILABLE



DOUBLE BUCKLE PADDED STYLE WITH SEWN-IN GULLET STRAP

With Ring (shown)
XL, Horse, or Cob
#5031 \$44

Without Ring (not shown)
XL, Horse, or Cob
#5030 \$40

OTHER SIZES ALSO AVAILABLE

PLEASURE STYLE NOSE BANDS (NOT PADDED)

Single Buckle Style #4011

HO \$25 PO \$21 MI (w/#121 buckle) \$20

Mini w/#12 buckle - #3303 \$18.⁵⁰

With Colored Trim #4013 HO \$32

Double Buckle Style (not padded)

Front Part - XL, Horse, or Cob #5019 \$16

Back Part - XL, Horse, or Cob #5022 \$19

CRANK STYLE NOSE BANDS (NOT PADDED)

#4195XL, Horse, or Cob \$40



NOSE BAND HANGAR STRAPS

All Sizes \$11.⁵⁰

#4012 - DR, HO, PO, MI

HAMES

All Hames are available in Kidney Link Style for no additional charge.

Stainless Steel with Swivel Terrets
21" #95835 \$110 pr

SOLID TERRETS ALSO AVAILABLE

Solid Brass Hames Loose Terret
w/ 2 Hole Clips
#95840 \$122 pr

Stainless Steel Show Style,
Loose Terret (includes bending fee)
#95830 \$192 pr



FOR BENDING ANY DRIVING HAME,
ADD \$40 PER PAIR



Hame Strap
Horse #4053 \$15.⁵⁰ ea

Kidney Links
V Style #95431 \$20
Show Style #96432 \$22

Long Tugs for Hames
#4075 (per pair)
HO \$184 PO \$162 MI \$148

Short Tugs for Hames
#4076 (per pair)
HO \$100 PO \$84 MI \$65



BREAST COLLARS

**Note: No Neck Straps are included in Breast Collar Prices*

AVERAGE V PADDED

PHOTO OF ITEM #4123



STANDARD ON OUR PADDED HARNESES

DR=DRAFT HO=XLARGE, HORSE, OR COB PO=PONY MI=MINI

XL, Horse and Cob Size Breast Collars

Single Adjustable Ave V Shaped #4123	HO \$224	PO \$200	MI \$178
Short Tug Ave V Shaped #4124	HO \$255	PO \$236	MI \$224
Long Tug Ave V Shaped #4125	HO \$365	PO \$340	MI \$290

PLEASURE

PHOTO OF ITEM #4031



STANDARD ON OUR PLEASURE HARNESES

DR=DRAFT HO=XLARGE, HORSE, OR COB PO=PONY MI=MINI

XL, Horse and Cob Size Breast Collars

Continuous, 3 Slots per Side #4030	HO \$184	PO \$140	MI \$73
Adjustable, for Single #4031	HO \$172	PO \$136	MI \$116
Long Tug #4032	HO \$315	PO \$280	MI \$255
Short Tug #4033	HO \$200	PO \$178	MI \$160
With Continuous Traces for Pair Harness #4034	HO \$218	PO \$166	MI \$112

Mini Economy Breast Collars*

Single, Continuous, Traces have 3 Slots in Back #3123	\$87
Pair, Continuous, Traces have 3 Slots in Back #3155	\$106

QUICK RELEASE HARDWARE BUILT ON ANY SIZE OR STYLE BREAST COLLAR

AVAILABLE WITH RING FOR ADJUSTABLE LINE OF DRAFT, ON SUPER V BREASTCOLLARS ONLY



Shown Apart

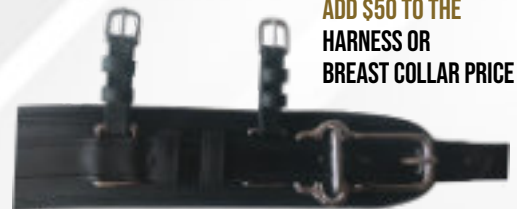

Shown Together (ready to drive)

ADD \$50 TO THE HARNESS OR BREAST COLLAR PRICE

This Breast Collar has an extra deep V shape designed so the horse can move more freely - and breath more easily. No more pressure on the wind pipe! The buckle is attached to a Ring which allows it to pivot to any degree of draft. Soft padding with rolled edges and more comfort for your animal. A must for all marathon occasions.

PRICING IS FOR BREAST COLLARS ONLY. NECKSTRAPS NOT INCLUDED.

	DR=DRAFT	HO=XLARGE, HORSE, OR COB	PO=PONY	MI=MINI
Single	#4160	HO \$290	PO \$260	MI \$240
Short-Tug	#4161	HO \$320	PO \$295	MI \$270
Long-Tug	#4162	HO \$440	PO \$370	MI \$350
Special V	#4165	HO \$320	PO \$295	MI \$275

SGL BREAST COLLAR	LENGTH	BUCKLE WIDT
Draft	52"	1-1/2"
XL	48"	1-1/2"
Horse	44"	1-1/2"
Cob	40"	1-1/2"
Pony	36"	1-1/4"
Mini B	32"	1"
Mini A	28"	1"

ALL SUPER V BREASTS (EXCEPT LONG TUG) COME WITH ADJUSTABLE LINE OF DRAFT UNLESS SPECIFIED OTHERWISE

For Pads to fit these Super V Breast Collars, [Ask for details](#)



SINGLE BREAST COLLAR



SHOWN IN AVERAGE V PADDED STYLE

Designed for use with one horse only. Made with Biothane and padded with a 3/8" thick felt that is wrapped with synthetic leather for a great feel and a comfortable horse. Works with buckle in traces and any type of carriage or cart. Our breast collars are priced breast collar only (no neck straps).

SINGLE BREAST COLLAR



SHOWN IN AVERAGE V PADDED STYLE

Just the same as the Single Breast Collar with the addition of 2 heavy dees in the front to run the brake strap through when driving a pair of horses. Best for a horse that you enjoy driving single or in a pair!

SINGLE BREAST COLLAR

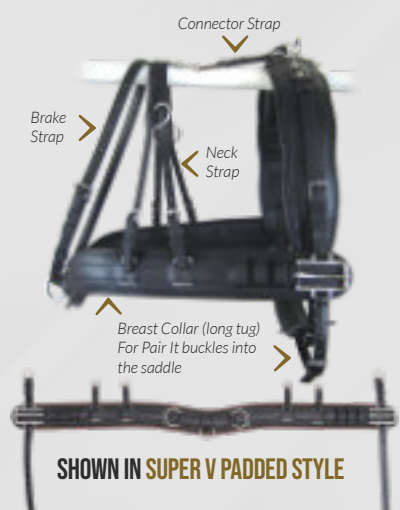

SHOWN IN SUPER V PADDED STYLE

For pairs only. This style is long enough to buckle into the saddle and girth eliminating the need for shaft loops (or trace carriers with pairs). Popular in marathon and combined driving events.

Items With Colored Trim MTC

Brow Band, padded w/Trim	#4115 - color	\$57
Nose Band, padded w/Trim	#4118 - color	\$62
Breast Collar, Ave V, padded w/Trim	#4123 - color	\$280
Breast Collar, Super V, padded w/Trim	#4160 - color	\$360
Breeching, padded w/Trim	#4128 - color	\$162
Saddle, padded w/Trim	#4131 - color	\$440

HORSE SIZE PRICES SHOWN



Breast Collar w/Road Plus Colored Edge Trim

SEE PAGE 62 FOR COLOR OPTIONS

Euro Collars MTC

	DR	HO	PO	MI
Single				
#4170	\$475	\$430	\$385	\$330
Short-Tug				
#4171	\$525	\$480	\$435	\$385
Long-Tug				
#4172	\$740	\$630	\$610	\$585
Euro Collar (top part only)				
#4169 Any size	\$59			



Neck Straps

	DR	HO	PO	MI
Single				
#4080	\$62	\$45	\$39	\$32
Mini Economy				
#3138				\$12.50
Team w/Loop for Brakestrap				
#4081	\$69	\$50	\$41	\$34
Mini Economy				
#3165				\$17
Brakestrap				
#4082	\$42	\$42	\$19	\$17.50



Neck Strap Bridge with Show Chain (extra)
#4216 **\$78**

Neck Strap Options

An adjustable Terret for neck straps

The ring can be up or down, the conway can be adjusted up or down, which gives a large amount of adjustment.

Terret, adj. style 1/2" conway 1-1/4" ring	#51121	\$15 each
Terret, adj. style 5/8" conway 1-1/4" ring	#51122	\$15 each
Terret, adj. style 3/4" conway 1-1/2" ring	#51123	\$20 each



- With Floppy Terrets - #4127 (sgl)
XL, Horse, or Cob **\$96**
- With Floppy Terrets - #4208 (pr style)
XL, Horse, or Cob **\$118**
- With Sliding Terrets - #4209
XL, Horse, or Cob **\$59**
- With Adjustable Terrets - #4218
XL, Horse, or Cob **\$71**



NECK STRAP	LENGTH	BUCKLE WIDTH
Draft	52"	3/4" or 1"
XL	48"	3/4"
Horse	44"	3/4"
Cob	40"	3/4"
Pony	38"	5/8"
Mini B	36"	1/2"
Mini A	32"	1/2"

False Martingales

1" wide with Teardrop (for breast collars)	#4049 HO	\$36
1" wide with Teardrop (for collars)	#4050 HO	\$37
3/4" wide with Teardrop (for breast collars)	#4048 HO	\$34
	PO	\$32
	MI	\$30
3/4" wide with Teardrop (for collars)	#4052 HO	\$35

DR=DRAFT HO=XLARGE, HORSE, OR COB PO=PONY MI=MINI

Saddles - Padded #4131

DR	5" with 1-1/4" Billets	\$415
	5" with 1" Billets	\$415
HO	4", with 1" Billets	\$350
PO	3", with 1" Billets	\$330
	2-1/2", with 3/4" Billets	\$295
MI	2-1/2", with 3/4" Billets	\$280



Standard Buckle widths are underlined

DR(with 1" & 1-1/4" Buckles)

HO(with 1" Buckles)

PO(with 1" or 3/4" Buckles)

MI(with 3/4" Buckles)

Width of saddle varies on model/size

Billets are approx. 1" on each side (measuring from end of saddle to longest hole, approx. 10" overall). Billet widths 1-1/4", 1", or 3/4".

OTHER SIZES AVAILABLE BY REQUEST

NECK STRAP	LENGTH	BUCKLE WIDT
DR	52"	1-1/4"
XL	48"	1"
HO	44"	1"
CO	40"	1"
PO	36"	3/4" or 1"
Mini B	32"	3/4"
Mini A	28"	3/4"

Girths



All Elastic with Wear Plates and Dees - #4029

DR (1-1/4" buckle) **\$75**

HO (1" buckle) **\$67**

MI (3/4" buckle) **\$56**

Treeless Saddles

Treeless Saddles have more "flex" to them, designed for that horse with the flat back

#4130 - HO4", with 1" Billets **\$325**

#5058 - MI2-1/2", with 3/4" Billets **\$216**

Saddle with Sliding Tugbearers

#4138 - HO4", with 1" Billets **\$385**

Treeless Saddles with Sliding Tugbearers

#5059 - MI2-3/4", with 3/4" Billets **\$222**

Pleasure Style - Has rolled edge



#4025

DR (1-1/4" buckle) **\$75**

HO (1" buckle) **\$62**

MI (3/4" buckle) **\$52**

Padded Girths

#4120



DR (1-1/4" buckle) **\$110**

HO (1" buckle) **\$83**

PO (3/4" buckle) **\$75**

MI (3/4" buckle) **\$75**

Deluxe Road Saddle - Marathon version

(Marathon version has Deluxe Billets)

Deep "gully" for horses with high spine. Your choice of colors for edges

#4177

HO **\$455**

PO **\$455**

MI **\$455**

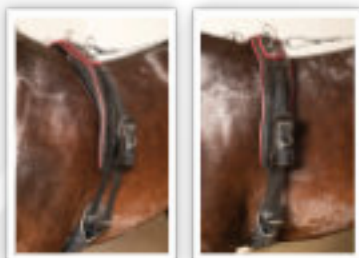

Over Girths #4026

DR (1-1/4" buckle) **\$19**

HO (1" buckle) **\$15.50**

MI (3/4" buckle) **\$11**

SIZING: GIRTHS (BUCKLE TIP TO TIP)

CUSTOM SIZES/ WIDTHS AVAILABLE

Note: Overgirths are same size

LENGTH	BUCKLE WIDT
DR 32" 1" or 1-1/4" (specify)	
XL 28" 1"	
HO 24" 1"	
CO 19" 1"	
PO 17" 1" or 1-1/4" (specify)	
Mini B use ponyuse pony	
Mini A 14" 3/4"	

Pleasure Style

HO - (4" with 1" Billets)

PO - (2-1/2" with 3/4" Billets)

MI - (2-1/2" with 3/4" Billets)

#4086

DR **\$290**

HO **\$250**

PO **\$136**

MI **\$118**



Saddles

Mini Economy Saddle - #3140

Flex Gig Style, with 3/4" Billets **\$98**

Mini Economy Belly Band - #3120 **\$28**

Replacement Parts Skirts Per Piece

Horse Size #4236 **\$43**



Tug Bearers Replacement Parts

Horse Size 1" #4234 **\$48 pr**

Pony Size 3/4" #4234 **\$42 pr**



DR=DRAFT HO=XLARGE, HORSE, OR COB PO=PONY MI=MINI

SHAFT LOOPS

Closed Shaft Loops - #4133 *Per pair*



XL, Horse or Cob

1" **\$82**
(RF welded holes for durability)

Pony/Mini

3/4" **\$69**
(RF welded holes for durability)



Quick Releases - #4240 *Per pair*



Draft (heat sealed holes)

1-1/2" SS **\$204**

Draft (heat sealed holes)

1-1/4" SS **\$87**

XL, Horse or Cob (RF welded holes)

1" SS **\$96**

Pony/Mini (RF welded holes)

3/4" SS **\$75**

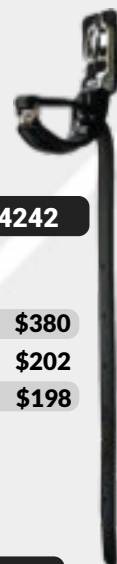

French Tugs #4242 *Per pair*

DR (1-1/4") **\$380**

HO (1") **\$202**

PO (3/4") **\$198**

Thimbles #3418

Mini size **\$66**

Pleasure Style

Made a little more on the economical side.

Horse Size with 1" Straps - #4090

DR (with 1-1/4" straps) **\$66**

HO **\$77**

PO/MI **\$40**



PERSONALIZE YOUR ITEMS... EMBROIDERY CAN BE ADDED

Closed Shaft Loops Without Billets #4243

HO (1") **\$40**

MI/PO (3/4") **\$24**



Economy Quick Release Shaft Loops #4241

DR (1-1/2") **\$176**

DR (1-1/4") **\$64**

HO (1") **\$56**

MI/PO (3/4") **\$41**

Marathon Wraps - #4245 *Per pair*

HO **\$50**

PO/MI **\$42**

Wrap Strap to go with Shaft Loops without Billets #4244

XL.HO.CO **\$33**

PO **\$25**



DR=DRAFT HO=XLARGE, HORSE, OR COB PO=PONY MI=MINI

Turnbacks

Draft Turn Back with Ring with Hip Straps Sewn in

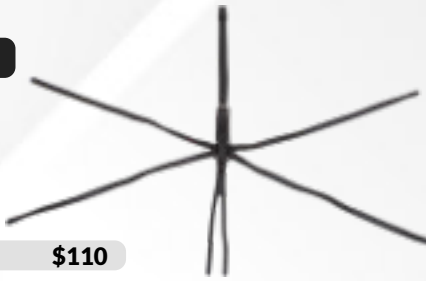

#4299DR \$110

#4099 XL/HO/CO \$40 PO \$30 MI \$25



TAKE A LOOK HERE!

A Turn Back with a Quick Release for safety issues

#4298 Any size available \$60



DESIGNED BY JOHN PORTER
Thank You John!

Double Hipstrap



With Dees - standard on padded harness

#4054 HO \$50 PO \$44 MI \$39

Without Dees - standard on pleasure harness

#4055 PO \$32 MI \$28

Mini Economy Hipstrap - #3130 \$14

Rein Guides

To put on Turn Back to pass reins thru



#4215 HO \$13 PO \$10 MI \$10

Hook Style

#12850 \$18 pr

Stainless steel

Slides onto a 3/4" wide hip strap



Cruppers

Our Shaped Synthetic Crupper

#4045 HO \$28 PO/MI \$25

Pony/Mini Pleasure #4046 \$23

Leather Crupper, Hand Stitched Keepers

Horse & Cob #82168 \$136

WE CALL THIS OUR FAT LEATHER CRUPPER

Leather Crupper, Hand Stitched Keepers

Horse & Cob #82169 \$88

Pony & Mini #82167 \$73

Crupper Cover

Made out of foam #4204 \$12.50

A nice, soft cover. Easy to clean, easy to replace. Just slip it off and put a new one on. Crupper not included.

Stiff Tail Crupper

#4043 \$77



DR=DRAFT HO=XLARGE, HORSE, OR COB PO=PONY MI=MINI

WANT TO GIVE SOMETHING BUT DON'T KNOW WHERE TO START?
WE OFFER GIFT CERTIFICATES...ANY \$\$ AMOUNT!

Breechings

Padded
#4128

DR \$148 HO \$114 PO \$102 MI \$91

Pleasure
#4040

DR \$102 HO \$93 PO \$72 MI \$59

#4039 Mini w/#121 Buckles \$57

#3126 (Mini economy) \$40

Holdbacks - For single

Average Style, no Snaps included

Draft - 1" wide bio/nylon sewed together
#4557 \$53 pr

Deluxe (per pair)
#4129

HO \$84 PO \$31 MI \$23

Pleasure (per pair)
#4058

HO \$42 PO \$31 MI \$23

Holdbacks - For pair

Side Backer Style, Long tug

#4060 (pr) XL,HO,CO \$54 MI,PO \$38

Side Backer Style, Short tug

#4059 (pr) XL,HO,CO \$55 MI,PO \$38

Side Backer Style, w/#12 Buckles at each end

#4061 (pair)
DR \$70 XL,HO,CO \$70 PO \$62 MI \$61

Belly Backer Style, w/Snap at one end

#4062 (pair)
DR \$35 HO \$35 PO \$27 MI \$26

**ROLLER BOLT TRACES
AVAILABLE**

Trace Carriers - For on Breeching

With Teardrop - #4092/ea.

HO \$20 PO \$18 MI \$18

Without Teardrop - #4093/ea.

HO \$12.50 PO \$9.50 MI \$9.50

Pony w/#121 Econ #3685/ea. \$10

Mini Econ #3170/ea. \$10.50

For at Saddle

#4094/pr DR \$54 HO \$72 PO/MI \$32
(1-1/4" BUCKLE) (1" BUCKLE) (3/4" BUCKLE)

Adjustable Trace Carrier

#4237/ea. HO \$13.50 PO \$12

Trace Carriers at Hips

#4091 \$63 ea

Bungee Style for Wheelers or Leaders without Breeching

Traces (priced per pair)

		1 1/2"	1 1/4"	1"
Trace w/Wears, slot end	#4136	\$112	\$102	\$59
Trace w/Wears, 3-way or roller bolt	#4137	\$132	\$124	\$86
Traces w/o Wears, slot end	#4096	\$104	\$88	\$42
Traces w/o Wears, 3-way or roller bolt	#4097	\$130	\$110	\$67
Traces for Hames, slot end, attaches directly to Hames	#4098	\$122	\$87	\$42

OVERALL MEASUREMENT - FROM TIP TO TIP (WHAT WE USE)



OVERALL MEASUREMENT - FROM TIP TO TIP (WHAT WE USE)

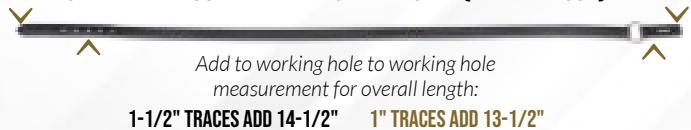

Draft, XL, Horse & Cob: 1-1/2" wide, available in 72, 75, 78, 81, 84, 87 and 90" *

Pony: 1-1/4" wide, available in 66, 69, 72, 75 and 78" *

Mini: 1" wide, available in 48, 54 and 60" *

*OTHER SIZES CAN BE CUSTOM MADE

DR=DRAFT HO=XLARGE, HORSE, OR COB PO=PONY MI=MINI

SINGLE DRIVING LINES

OUR PADDED AND PLEASURE HARNESS USUALLY HAVE THE FOLLOWING WIDTH OF LINES UNLESS OTHERWISE REQUESTED.
 MINI - 5/8" • PONY, COB, HORSE, WARM BLOOD & DRAFT - 3/4". WIDER SIZES AVAILABLE ARE: 7/8" (ADD \$12) AND 1" (ADD \$20)

THESE REINS ARE MADE OF A DARK BROWN BETA WITH BUCKLE IN HAND

Single Lines - #4070

With Buckle In Hand. Standard on all harness.

Draft	3/4" x 16'	\$69
XLarge	3/4" x 15'	\$64
Horse	3/4" x 14'	\$64
Cob	3/4" x 13'	\$64
Pony	3/4" x 12'	\$59
Mini	5/8" x 10'6"	\$46



LINE OPTIONS FOR BACK PART OF LINES (add to cost of lines)

#4072 Swivel instead of Buckle **+\$19.50**



#4073 Bumpy Rein Grip **+\$24**



#4064 With 16 Stops **+\$25**
 Extra stops **+\$1 ea.**



#4326 Rubber Gripper **+\$10**



#4320 Smooth Rein Grip **+\$9**

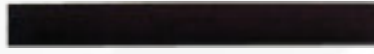

#4069 Pinky Loop **+\$7**



#4071 Leather in Hands **+\$64**



#4068 Single Ply Cotton **+\$13.50**

#4067 Double Ply Cotton **+\$31**



Standard is 1" wide
(3/4" available by special order)

#4066 Braids **+\$60**



#4065 Lace **+\$91**



#4337 Rolled Leather Hand Parts **+\$73**



Single Leather Lines - #4330

Russet with Dyed Edges with Hand-stitched Keepers.

Draft	3/4" x 16'
XLarge	3/4" x 15'
Horse	3/4" x 14'
Cob	3/4" x 13'
Pony	3/4" x 12'
Mini	5/8" x 10'6"

Call for Prices



Single Leather Lines - #4331

Russet with Un-dyed Edges, Staped Keepers 3/4".

Draft	3/4" x 16'
Xlarge	3/4" x 15'
Horse	3/4" x 14'
Cob	3/4" x 13'
Pony	3/4" x 12'
Mini	5/8" x 10'6"

Call for Prices

LEATHER LINE OPTIONS

- #4340 Leather Swivels instead of Buckle in Hand
- #4339 Leather Stops in Hand 16 stops
- #4338 Leather Pinky Loop

CUSTOM BETA COLORS - ADD 20% SURCHARGE

STOCK COLOR								
	BR523 BROWN							

ACCESSORY ITEMS

#4310 Pinky Loop with key ring **+\$6.50**

Split key ring allows you to add this to your existing lines via the buckle

Swivels

Swivel with 3/8" Buckles #4247 **+\$20**



Swivel with 3/4" or 5/8" Buckle, will Buckle to your Existing Reins #4248 **+\$16.50**



TEAM DRIVING LINES AVAILABLE IN BLACK OR BROWN

Team Lines - #4074

Draft/Xlarge	3/4" x 18'	\$136
Horse/Cob	3/4" x 16'	\$114
Pony	3/4" x 15'	\$112
Mini	5/8" x 11'	\$77

***WHEN BUYING 4-UP, 6-UP OR TANDEM REINS, PRICES ARE ONLY FOR THAT SET. THESE PRICES DO NOT INCLUDE REINS FOR THE WHEELER OR SWING TEAMS.**

4-Up Lines* for Leaders Only - #4282

Draft	3/4" x 30'	\$160
XLarge	3/4" x 28'	\$148
Horse	3/4" x 26'	\$148
Cob	3/4" x 24'	\$148
Pony	3/4" x 22'	\$138
Mini	5/8" x 18'	\$106

6-Up Lines* for Leaders Only - #4287

XL/Horse/Cob	3/4" x 36'	\$170
--------------	------------	--------------



Tandem Lines* for Leaders Only - #4078

Draft	3/4" x 30'	\$114
XLarge	3/4" x 28'	\$104
Horse	3/4" x 26'	\$104
Cob	3/4" x 24'	\$104
Pony	3/4" x 21'	\$80
Mini	5/8" x 18'	\$59

INTERESTING HITCHES THAT HAVE BEEN DONE

Note: There are many ways to do some of these, here are a few. For advanced drivers.

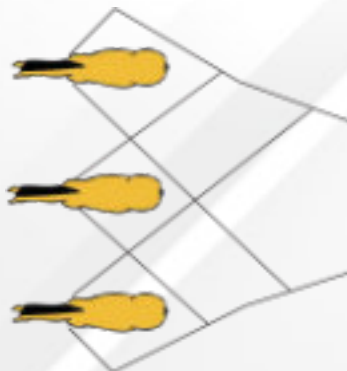

Team Lines, Leather - #4335

Russet with dyed edges and Hand-stitched Keepers

Horse/Cob	3/4" x 16'	Call for Prices
Mini	5/8" x 11'	

Team Lines, Leather - #4336

Russet with undyed edges Stapled Keepers

XLarge/Draft	3/4" x 18'	Call for Prices
Horse/Cob	3/4" x 16'	
Pony	3/4" x 15'	
Mini	5/8" x 11'	

FOR 4-UP AND 6-UP LEATHER LINES, PLEASE CALL FOR PRICING

Tandem Lines, all leather* for Leaders Only

#17711 Call w/Size For Pricing

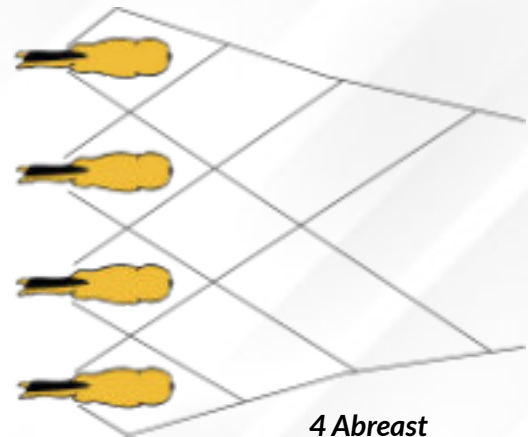

**4 Abreast
1 set of lines**

**3 Abreast
1 set of lines**

HORSE & COB OPTIONS AND MISCELLANEOUS PARTS

Special Items

Cavasons #4182 (each)		
HO \$36	PO \$31	MI \$29
Cross Tie Collars #4200 \$19.50 ea		
Flash with Adapter for Nose #4191 \$16 ea		
Hame Balls on Top of Hames #95600 \$26 pr		
Seat Straps #4235 \$12.50 ea		
Trim Kits #4279 \$29 ea		
Thimbles for Minis #3418 \$66		



Connector Straps w/#56 Snap

#4083	HO \$22	PO \$22	MI \$20
-------	---------	---------	---------



Evener Straps

3/4" - 5' Unfolded #4205	\$41pr
1" - 5' Unfolded #4206	\$45 pr



Kicking Straps

Quick Release Style #4214

HO	\$100
PO	\$88
MI	\$85



#4212 - Kicking Strap

Horse	\$54 ea
Pony	\$49 ea
Mini	\$37 ea



Kicking Strap With Snaps

#4210	HO \$106	PO \$96	MI \$94
-------	----------	---------	---------



Pole Straps (each)



Breast Collar

#4084	HO (1") \$26	PO (1") \$25	MI (3/4") \$14.50
#4084 for Breast Collar	DR (1-1/4") \$34	DR (1-1/2) \$35	

SIZE, SHORTEST TO LONGEST:
MI 4-1/2 - 6-1/2, PO 8-1/2 - 13, HO 12 - 15-1/2

Collar

#4085	HO (1") \$32	PO (1") \$32	MI (3/4") \$24
#4085 for Collar	DR (1-1/4") \$40	DR (1-1/2) \$40	

Pole Strap w/447 snap	#4222	\$53 ea
Pole Strap, Bermuda Style, 1-1/2" wide	#4223	\$69 ea
Wearplate w/Dee for Bermuda Style	#4224	\$10.50 ea
Pole Strap Horse		

OPTIONS & ADD ONS

For patent look on any harness, take the price of the harness part that you would like to have patent on, and **add 20%**, or a minimum of \$4 per part. Example: on a padded single harness and bridle, we have about 6 places to put patent look for approx. **\$100-\$150**.

1-1/2" Billets with 2-1/2" Girth	\$20 ea
1-1/4" Billets with 2-1/2" Girth	\$15 ea
3-1/4" wide Breast Collar	\$15 ea
2-1/2" wide Breeching	\$10 ea
2 Heavy Dee Rings Built into Breast Collar	\$20 ea
Russet on Inside of Cups	\$18 pr

NOTE: FOR RUSSET AND/OR BRASS ADD 20% TO HARNESS PRICE

4 in Hand Parts

Coupling Strap w/Tear Drop for Leaders

#4280	HO \$58	PO \$58	MI \$58
-------	---------	---------	---------

Coupling Strap without Tear Drop

#4281	HO \$43	PO \$43	MI \$43
-------	---------	---------	---------



3 Ring Martingale - #4225

Horse	\$26 ea	Pony	\$26 ea	Mini	\$21 ea
-------	----------------	------	----------------	------	----------------

TANDEM PARTS

Center Terrets

#51108 **\$33 ea**
5/16" Thread w/1-3/4" ring



Roger Rings

With Strap #4197 **\$29 pr**

Oblong style Roger Ring #4196 **\$93 ea.**
- includes Throat Latch



Tandem Cockkeys

Spring Style, 1-1/2" #68712 **\$81 pr**
Spring Style, 1-1/4" #68713 **\$60 pr**

Chupp Style, 1-1/2" #68705 **\$28 pr**

Tandem Keys #68715 **\$28 pr**



Tandem Rosettes

1" with 1-1/8" Ring #02796 **\$19 pr**
1-1/4" with 1-1/4" Ring #02798 **\$19 pr**
1-5/8" with 1-3/4" Ring #02799 **\$20 pr**
2" with 1-3/4" Ring #02805 **\$20 pr**



Tandem Terrets

With Rollers, 1-1/4", per pc. #51109 **\$19.50 ea**
With Rollers, 1-1/2", per pc. #51110 **\$21 ea**



Tandem Terret, Double Ring Style, Horse Size

with 1-1/2" Top Ring, #51112 Horse **\$38 ea**
1-5/8" Bottom Ring, Double Ring Deluxe

Tandem Terret, Mini/Pony Size

with 1-1/4" #51112 Mini/Pony **\$38 ea**
Double Ring Deluxe Style S/S

Tandem Traces, No Wears, No Hardware

1-1/4" x 120" #4140 **\$128 pr**
1-1/2" x 120" #4141 **\$130 pr**

Tandem Keepers for lines

#4293 **\$19 pr**



Tandem or Single Strap Hip Straps

#4294 **\$22 ea**



Trace Carrier for Tandem Hip

With Teardrop #4296 **\$20 ea**
Without Teardrop #4295 **\$11.50 ea**



TRACE EXTENSIONS

Trace Extension with Heavy Dee to Convert your Slotted Traces - #4250

#4250 1-1/2" **\$53 per pr**
#4250 1-1/4" **\$48 per pr**
#4250 1" **\$45 per pr**



Trace Converter - Dee to Slot Any Width - install yourself

#4259 **\$23 per pr**



Trace Converter - Slot to Chain End

#48815 **\$17.50 ea**



Trace Extension with 2 Slots

#4253 1-1/2" **\$62 per pr**
#4253 1-1/4" **\$55 per pr**
#4253 1" **\$37 per pr**



Trace Extension with Roller Bolts to Convert your Slotted Traces for Roller Bolts

#4256 1-1/2" **\$71 per pr**
#4256 1-1/4" **\$66 per pr**
#4256 1" **\$61 per pr**



The #360 Trace Converter or Trace Extension



#36001 1-1/4" **\$2**
#36000 1-1/2" **\$3.25**

Carriage Tie Downs

2-1/2" x 15"

#05300 **\$33**

4" x 19"

#05310 **\$37**



Chopping Block

USE WITH THE HAND PUNCHES

3" x 6"

#00478 **\$11**



Punches

#223 Revolving Punch
#00480 **\$24**

Double Revolving Lever
Action Punch
#00492 **\$65**

#245 Hand Punches

#3 for Small Holes
#00479-03 **\$9**

#6 for Large Holes
#00479-06 **\$10**



Number Holders & Belt for Marathon Driving

IN BLACK OR RUSSET



Short Style

#4264 **\$23**



Long Style

#4265 **\$28**



Strap Style

#4266 **\$33**

Small Round Style
(Black or Russet)

#4267 **\$26**



Safety Belt for Marathon Driving
#4269 **\$60**

Rein & Trace Splice

3/4" for Reins #4273 **\$9.50**

1-1/2" for Traces #4274 **\$21**

AVAILABLE IN BLACK OR BROWN
SPECIAL SIZES ARE AVAILABLE (CUSTOM)



Spares Kit AVAILABLE IN BLACK OR BROWN

Synthetic Spares Kit
without Accessories #4260 **\$134**

Synthetic Spares Kit
with All Accessories #4261 **\$280**

Leather Spares Kit
without Accessories #4262 **\$194**

Leather Spares Kit
with All Accessories #4263 **\$325**



SHOWN W/O ACCESSORIES

Spares Kit Accessories

Available in Black or Brown

- Adj. Wheel Wrench #53000 **\$69**
- Hammer #53011 **\$7.50**
- Lacing, 3/16" x 6' #53200 **\$2.50**
- Hoof Pick #53250 **\$1.45**
- Vise Grip #53500 **\$13.50**
- Pocket Knife Barrow #53570 **\$6**
- Horseshoe Nails #53251 **\$0.30**
- #223 Revolving Punch#00480 **\$24**
- 3/4" Hame Strap #4053 **\$15.50**
- 3/4" Rein Splice (Black or Brown) #4273 **\$9.50**
- 1", 1-1/4" or 1-1/2" Trace Splice #4274 **\$21**



SHOWN W/
ACCESSORIES

Harness & Bridle Bags

Harness Bags

#30030 Draft **\$108**
26" h x 30" w x 10" d

#30031 Horse **\$86**
24" h x 28" w x 8" d

#30032 Mini **\$72**
20" h x 22" w x 6" d

Bridle Bags

#30035 Horse **\$63**
20" h x 12" w x 7" d

#30036 Mini **\$59**
14" h x 10" w x 5" d



COLORS:
ROYAL BLUE, NAVY,
MAROON, GREEN AND BLACK

Made with Cordura on the outside for strength and a breathable wool on the inside to keep your harness drier. Comes with carry handles on the top and three velcro straps on the inside to keep the harness organized. Closes with a zipper.

Diaper Bags

Includes 2 straps to go to shafts and 2 straps to breeching

#24997

- Mini **\$78**
- Horse **\$79**
- Draft **\$80**

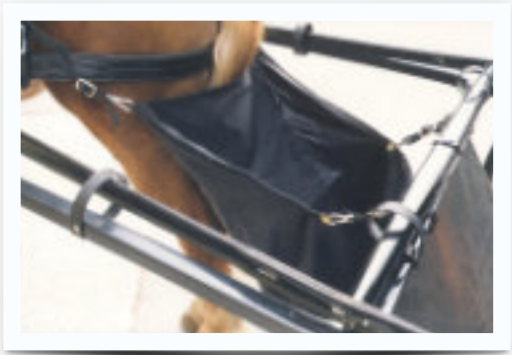

Cart or Lunge Whips

- #11120 72" with 18" drop, Solid Black **\$27**
- #11124 88" with 48" drop, Solid Black **\$51**
- #11130 60" with 18" drop, Solid Black **\$25**
- #11132 Cart Whip (49" whip plus popper) **\$8.⁵⁰**
- #11237 Stock Yard Whip **\$15**
3 colors - Speckled White with Red, Blue or Green
- #11134 56" with 73" drop **\$34**

Black with White Handle Dressage Whips

- #11160 54" with 16" drop **\$43**
- #11162 70" with 24" drop **\$44**



Caution Signs

MADE WITH ALL SYNTHETIC MATERIALS

The outside has a 2" wide reflective material. The back side has a Velcro strap sewn on, to loop around your rear axle or seat back of your vehicle.

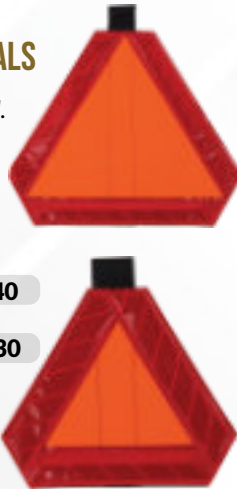

- #4154 - Large Size -16" x 14" **\$40**
- #4153 - Small Size -11" x 9" **\$30**

NEED BELTS?



MOSEY OVER TO PAGE 7

NEED RIDING TACK?



GALLOP TO PAGE 20

EQUILIB MARATHON HORSE ARMOR SADDLE PADS

Equilib Marathon Horse Armor Saddle Pads

This high density armor pad was invented to protect the horse from the carriage shafts during marathon maneuvers by advanced combined driving competitor, Marnie Hutcheson in 2001. They are available in stock in 4 standard sizes (Pony, Medium, Large, and Extra Large). The 3 pictures below show how these pads work.

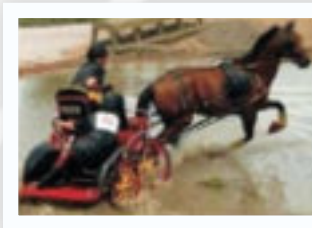
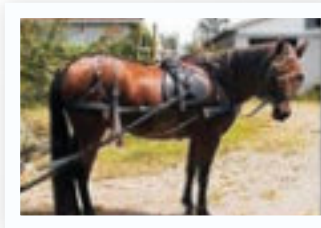

MADE WITH A SQUARE WEAVE VINYL PATTERN

We can also custom make anything you may need such as longer, shorter, wider or with the extra "D" pad behind the saddle as well as in front.

special high density "D" shaped pad in front of the saddle protects the horse's shoulder from the inside shaft tip, and padding behind the saddle protects the horse ribs from the outside shaft when they bend into a turn. Many large bodied horses need extra protection behind the saddle.

If you want an extra "D" pad behind the saddle as well as in front add: \$50 to your size.

PICK THE RIGHT SIZE PAD FOR YOUR HORSE AND CARRIAGE...

The tip of the shaft (sweet spot) is at:

- **Pony Size:** 13.5" down from the backbone and 4.5" forward from the center of the saddle
- **Horse Size:** 14.5" down from the backbone and 5" forward from the center of the saddle
- **Large Horse:** 15.5" down from the backbone and 5.5" forward from the center of the saddle
- **Extra Large Horse:** 20" down from the backbone and 7" forward from the center of the saddle

#4301	Extra Large - (X) - 44" Long	\$142
#4301	Horse - (L) - 42" Long	\$142
#4301	Cob - (M) - 40" Long	\$142
#4301	Pony - (P) - 38" Long	\$142

Marathon Pads - #4173

Available in Horse, Pony and Mini sizes **\$77 pr**



Soft side against horse



Hard side on outside

Note: Soft side against the horse, hard side on outside

DEVELOPED WITH THE AID OF MARJEAN MCINTYRE AT CAMPTOWN HARNESS AND SOLD WITH HER PERMISSION



Neoprene waffle. Economical version Of the Equilib pad.

Bone Shaped Saddle Pads - Great for Marathon

Warm Blood	1/2" x 42"	#92093	\$102
Horse	1/2" x 38"	#92092	\$89
Cob	1/2" x 34"	#92091	\$82
Pony	1/2" x 30"	#92090	\$74
Mini	1/2" x 28"	#92089	\$62

Nothing is more expensive than a free horse

PLEASURE DRIVING

PADS - AIR FLO STYLE & NEOPRENE STYLE

- MAROON
- RED
- YELLOW
- LIME
- KELLY
- REFL GREEN
- TEAL
- ROYAL
- DARK ROYAL
- NAVY
- TAN
- PURPLE
- BLACK
- REFL BLACK
- CHARCOAL
- REFL SILVER
- GRAY
- WHITE



- CREAM (NOT SHOWN)
- FOREST (NOT SHOWN)
- REFL BLUE (NOT SHOWN)

CHECK THESE OUT!

Now available by request with a 2-4 week lead time. These pads are made with Colored Vinyl on the top and with black Neoprene on the bottom side.



THIS IS A VERY NICE PAD!

Neck Strap Pads

A soft pad for the Neck Strap, Neoprene

Horse or Cob 3-1/2" x 9"

#92005 **\$24**

Pony or Mini 3" x 7"

#92012 **\$24**

Saddle Pads

		NEOPRENE	AIR FLOW OR COLORED VINYL
Warm Blood	1/2" x 8" x 28"	#92000 - \$50	#92530 - \$60
Horse	1/2" x 6" x 24"	#92001 - \$42	#92531 - \$51
Cob	1/2" x 6" x 18"	#92002 - \$36	#92532 - \$44
Pony	1/2" x 4" x 16"	#92003 - \$28	#92533 - \$34
Mini	1/2" x 3" x 15"	#92004 - \$27	#92534 - \$33



Air Flo Style Shown



Neoprene Style Shown

Breast Collar or Breaching Pads - Straight

		NEOPRENE	AIR FLOW OR COLORED VINYL
Warm Blood	1/2" x 5" x 48"	#92020 - \$51	#92520 - \$62
Horse	1/2" x 6" x 42"	#92026 - \$45	#92519 - \$62
Horse	1/2" x 5" x 40"	#92021 - \$45	#92521 - \$54
Horse	1/2" x 4" x 40"	#92022 - \$39	#92525 - \$47
Cob	1/2" x 5" x 36"	#92023 - \$44	#92522 - \$53
Pony	1/2" x 3-1/2" x 31"	#92024 - \$34	#92523 - \$41
Mini	1/2" x 3" x 26"	#92025 - \$33	#92524 - \$40



Breast Pads - Average V-Shaped

		NEOPRENE	AIR FLOW OR COLORED VINYL
Draft	1/2" x 5" x 51"	#92038 - \$62	#92508 - \$75
XL	1/2" x 5" x 47"	#92039 - \$59	#92509 - \$71
Horse	1/2" x 5" x 43"	#92040 - \$57	#92510 - \$69
Cob	1/2" x 5" x 39"	#92041 - \$56	#92511 - \$67
Pony	1/2" x 4" x 35"	#92042 - \$52	#92512 - \$63
Mini - B	1/2" x 3-1/2" x 31"	#92044 - \$46	#92514 - \$56
Mini - A	1/2" x 3-1/2" x 27"	#92043 - \$46	#92513 - \$56



Super V-Shaped Breast Pads

		NEOPRENE	AIR FLOW OR COLORED VINYL
Draft	5 1/2" x 46"	#92059 - \$64	#92506 - \$77
Warm Blood	5" x 42"	#92060 - \$60	#92500 - \$72
Horse	5" x 38"	#92061 - \$57	#92501 - \$69
Cob	5" x 34"	#92062 - \$53	#92502 - \$64
Pony	3-1/2" x 32"	#92063 - \$51	#92503 - \$61
Mini - B	3-1/2" x 28"	#92065 - \$48	#92505 - \$58
Mini - A	3-1/2" x 25"	#92064 - \$48	#92504 - \$58





Creatine

#07444 **\$180**

- 99.5% Pure Creatine.
- Helps provide more energy to muscles.
- Increases strength, speed, power and endurance.



MSM

#07445 **\$34**

- 99% Pure MSM.
- No sugar or fillers added.
- Good for tendons, ligaments and joints.
- Also helps for arthritis.

Old Fashioned Hoof Dressing

Qt w/o Brush #07572 **\$12.50**
 Qt w/ Brush #07571 **\$14**
 1 Gal #07573 **\$44**



Equimax Wormer



#07650 **\$19.50**

Removes Tape Worms. Treat and protect your horse from the most common parasitic threats with one safe, effective compound. safe for all horses, including foals four weeks of age and older, pregnant and lactating mares, and breeding stallions.

1.87% Ivermectin - 14.03% Praziquantel

Bimectin Wormer

#07594 **\$9.50 ea**

100+ PIECES - CALL FOR CURRENT PRICE

Controls large and small strongyles, pinworms, ascarids, hairworms, large mouth stomach worms, lungworms, intestinal threadworms and bots. Safe for pregnant mares, breeding stallions and foals.



1.87% Ivermectin Package may vary

Rabbit's Jug



Tube - #07468 - **\$8.95**
 Case of 15 tubes - **\$8.25 ea**

Rejuvenates your horse with electrolytes, minerals, vitamins and amino acids

Suspensory & Tendon Care/Treatment Plan

#07514 **\$57**

Contains:

- Tightener & Sweat
- Magic Tightener
- Heavy Blister
- Treatment Plan



2 Wraps and 2 Bandages

#07513 **\$29**

Yoder's Hoof Dressing

Qt w/o Brush #07510 **\$17.50**
 Qt w/ Brush #07511 **\$20**
 1 Gal #07512 **\$53**

OUR FAVORITE HOOF DRESSING!

Hoof Builder is a strengthener, conditioner and stimulator. Yoder's was developed and used by the Amish and Mennonites in Lancaster County, Pennsylvania for decades and now is available to you!!



Brush Only

#07570 **\$3.25**



Horse Heave Special

This has been used by great horsemen for many years and has been proven over and over for its effectiveness. It's all natural and can be used on race days. If used daily it builds up the immune system. A must for horses with cold symptoms, fever, sore throat or horses that just don't finish well.

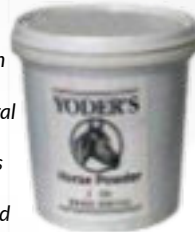

Very inexpensive and a must for today's competitive racing

1 lb. #07672 **\$11.50**
 5 lbs. #07673 **\$43**
 25 lb. pail #07675 **\$210**

Haarlem Oil

#07532 **\$6**

Used to prevent tying up

- Contains Juniperberry tar used as a natural diuretic for oral equine use only.
- Helps induce urination and prevent tying up.
- Dose whole syringe or as per vet instructions



Super Shine

#07589 Clear **\$19**
 #07590 Black **\$19**



Fast drying hoof polish and sealer.

Leg Soaker

#44145
\$44



Rabbit's Tightener & Sweat

16oz



#07501 **\$22.95**
#07504 gallon **\$159**

For feet & 1/4 cracks, ankles & oslets, bow tendons, check ligaments, knees & hocks, shoulders & backs, muscle soreness. Will not blister.

Rabbit's Magic Tightener

16oz



#07502 **\$24.95**

Relieves muscle soreness, stifles and great for suspensories and bowed tendons.

Rabbit's Dr. Barbers Solution

16oz



#07473 **\$19**

An excellent counter irritant used for the relief of muscle soreness, curbs, splints, ringbone, bowed tendons and knees due to extreme overexertion.

Rabbit's Hot Lick

2 lbs. #07453 **\$39.75**
6 lbs. #07454 **\$79.95**
30 lbs.#07452 **\$295**



Equine Nutritional Supplement formulated to help horses reach their potential. It helps to reduce lactic acid, which can reduce the incidence of tie up. Hot lick potentiates the production of energy to ultimately increase the overall performance for the racehorse. Can be used everyday or as a Pre-race.

Rabbit's Breathe Easy

3 lbs. #07484 **\$150**
10 lbs. #07485 **\$325**

Helps clear mucus from throat & lungs. Great for allergies. It is a natural bronchial dilator.



Rabbit's Ultra Block Gel

#07432 **\$24.75**

This is a topical block for pain. Great for knees, feet and oslets.



Rabbit's No Tye

5 lbs. #07460 **\$89.95**
30 lbs. #07458 **\$395**
Tube #07463 **\$10**
Case of 15 tubes **\$9.50 ea**



Feed at the rate of 1/2 oz. daily (1 scoop) for performance horses.

Rabbit's Rites Knee, Stifle & Hock Paint

#07430 **\$21.95**

8 ounces Iodine base, ether. Clip area, shake well and do not bandage.



Xzantrol The Power To Breathe

#07442 **\$39.95**

Results in 5 minutes. Helps clear sinus cavities & guttural pouches. Removes mucus, dirt & dust from nasal passages.



Rabbit's Magic Hoof Packing with Ultra Block

4 lbs. #07476 **\$45**
10 lbs. #07477 **\$100**

To help relieve pain in the hoof of the equine animal. It is great for most all soreness within the hoof. Providing relief from laminitis, abscesses, navicular, bruising & corns.



Rabbit's Ber-Band

8oz

#07480 **\$15**

For the symptomatic relief of temporary pain and discomfort associated with bucked shins, splints, osselets, big knee, swellings, sore tendons and muscular soreness. To be used as an aid in the temporary relief of minor soreness and stiffness caused by overexertion.



Rabbit's T.Q. Powder

1.2 lbs. #07436 **\$37.95**
5 lbs. #07437 **\$135.95**
Tube #07438 **\$9.95**
Case of 6 tubes **\$9.50 ea**

Formulated to help calm down nervous, high strung horses. Will not hinder performance.



One reason why birds and horses are happy is because they are not trying to impress other birds and horse – Dale Carnegie

BE SEEN... SAVE A LIFE!

REFLECTIVE PARTS ARE VISIBLE
UP TO 700+ FEET

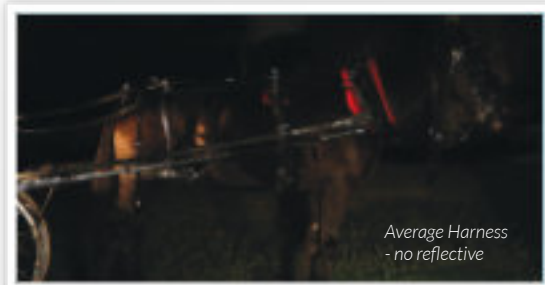
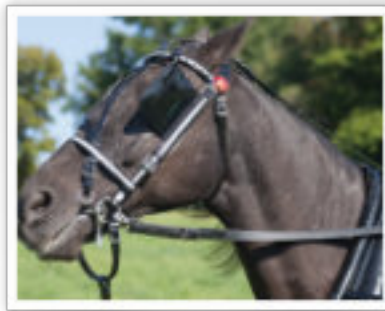

CALL FOR REFLECTIVE HARNESS PRICES TODAY!



Black Reflective available
in the Semi-Gloss
Biothane Harnesses!!



4 colors of Reflective Pads
to choose from:

- BlackGreen ◦
- Royal BlueSilver◦



Saddle Pad	#17904	\$26
Split Breast Pad	#17900	\$43
Collar Pad	#17902	\$47
Breeching Pad	#17906	\$27
Super V Breast Pad	#17901	\$44



Neck Strap
#2258

101 W/SILVER
REFLECTIVE

281 W/BLACK
REFLECTIVE

	101 W/SILVER REFLECTIVE	281 W/BLACK REFLECTIVE
#2248Bridle	\$212	\$216
#2252Nose	\$7.50	\$7.50
#2250Brow	\$9.50	\$10
#2251Brow w/spots	\$13	\$13.50
#2067Saddle	\$122	\$122
#2254Blinds	\$94	\$96
#2264Traces	\$112	\$114
#2244Super V w/clip	\$188	\$192
#2246Super V w/side opening	\$184	\$188
#2256Lines - Lancaster style	\$118	\$122
#2270Reflective w/Bump - Econ.	\$93	\$96
#2287Reflective w/Beta - Econ.	\$85	\$90
#2290Horse Dealer Halter	\$60	\$63
#2260Hip Strap	\$19.50	\$21
#2258Neck w/dees	\$39	\$40

Standard Features on Amish Driving Harness...

- ◉ Shaped Crown
- ◉ Spots on the Browband
- ◉ Shaped Hipstrap
- ◉ Includes Snaffle Bit and Overcheck Bit
- ◉ Includes Holdbacks

PADS NOT INCLUDED IN PRICING

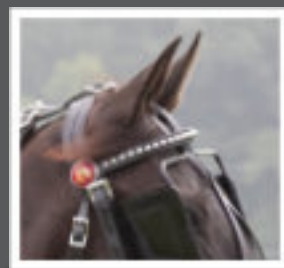

Harness Options...

For more Girth options

SEE PAGE 23



Ornaments on Blinds
(one on each Blind)

SEE PAGE 14



Want to add Spots
and/or Diamonds?



SEE PAGE 68 FOR DETAILS!!



For more Browband options

SEE PAGES 46 & 68



Rosette Options

SEE PAGE 14

**WANT SOMETHING CUSTOM
ON YOUR HARNESS?? NO PROBLEM!!**

**JUST TELL US WHAT YOU WANT WHEN
YOU PLACE THE ORDER AND WE WILL TRY!**



For Prices on
Complete Harnesses

SEE PAGE 67

Continuous Lines

- ◉ Standard on Driving Harnesses
- ◉ Light on horses mouth
- ◉ Standard one piece (no split)
Extra grippy lines have split.
- ◉ Shorter snap area, allows
more room for pulleys



**NEED
RIDING TACK?**

TROT TO PAGE 19

FOR DETAILS



COMPLETE DRIVING HORSE HARNESS SETS

Choose your finish on the Harness 101 (Shiny) or 281 (Leather Look), available with Stainless Steel or Black Stainless Steel Hardware.

		101 (SHINY)	281 (LEATHER LOOK)
Complete Harness Bridle with Black Stainless Steel Hames	#2162	\$685	\$695
Complete Harness Bridle with Black Hybrid Hames	#2160	\$670	\$685
Complete Harness Bridle with Stainless Steel Hames	#2161	\$695	\$705
Complete Harness Bridle with Continuous Quick Release Super V Breast Collar	#2168	\$705	\$720
Complete Harness Bridle with Split Front Super V Breast Collar	#2167	\$695	\$725

* Old style Straight/Average V Breast Collars are still available. Call for prices



The price on the complete driving sets includes **bridle, bits, elastic belly band, and hold backs.** If you are looking for added safety features on your harness, check out page 65 for our reflective harness options.

For more options on the browband, **See pages 46 and 68.** For more options of the rosettes or ornaments **see page 14.** For more options on bits, **See pages 32-35.**

SEE PAGE 11 FOR PAD COLORS



PRICE SHOPPING?

OUR HARNESSES INCLUDE: BACKERS, BOTH BITS, CHOKESTRAP AND MARTINGALE (\$80+ VALUE)

BRIDLES

Overcheck Bridle (includes Overcheck and Snaffle Bits, Martingale, Stainless Steel Horse Head Rosettes and Spotted Browband)	#2150	\$184
Quick Hitch Bridle (Overcheck Bridle with Single Rein-Up, no Martingale, Hex Spots on Browband, Half Noseband, with Colored Trim on Nose and Browbands, Stainless Steel Horse Head Rosettes and Ornaments on the Bridle)	#2153	\$188
Deluxe Sidecheck Driving Bridle (Stainless Steel Keepers, Sidecheck Rein, Teardrop, Weaver Show Chain on Browband, built-in Full Noseband, with Color Trim on Teardrop, Nose and Browbands, and Stainless Steel Horse Head Rosettes)#2158		\$246
Pappy Bridle (has no Face Piece and includes Snaffle Bit, Black Bio Rosettes, Sidecheck Rein and Plain Browband)	#2151	\$172
Combination Bridle (includes Overcheck and Snaffle Bits, Face Piece, Martingale, Stainless Steel Horse Head Rosettes, Spotted Browband, Sidecheck Rein)	#2152	\$202

BREASTCOLLARS

When you buy a new Complete Breast Collar Set, you need to order the Breast Collar, Neck Strap, Choke Strap, and Breast Collar Pad. See item numbers below.

Continuous Quick Release Super V Breast Collar with Molded Traces	#2046	\$160
Super V Breast Collar with Split Front with Molded Traces	#2044	\$162

NECK STRAPS AND CHOKE STRAPS

Neck Strap with Dees sewed in	#2054	\$32
Neck Strap with Sliding Territs	#2047	\$37
Neck Strap with Line Ring Straps	#2058	\$38
Choke Strap for Breast Collar	#2073	\$14. ⁵⁰

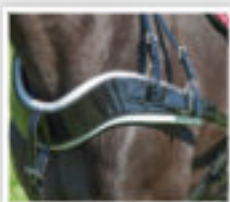

**SUPER V
BREAST COLLAR
#2046 SHOWN**



QR SIDE OPENING
For Comfort of the horse
one piece pad in front.

#2047



#2058



DRIVING HARNESS & BRIDLE PARTS

All parts available in 101 or 281 unless otherwise marked

Harness Parts *Stainless Steel or Black*

Belly Band - Elastic Style #2050	\$28
Belly Band - Rolled #2051	\$33
Breeching #2055	\$55
Breeching - Double Buckle Style #2056	\$55
Choke Strap #2060	\$15
Crupper #2063	\$16. ⁵⁰
Hame Strap - Single Ply #2070	\$6. ⁵⁰
Hame Strap - Single Ply, Extra Long -29" #2072	\$7. ⁵⁰
Hames -Black Hybrid, no Terrets w/Clips #95870	\$55
Hames -Stainless Steel, no Terrets w/Clips #95619	\$86
Hames -Stainless Steel Powder Coated Black no Terrets w/Clips #95120	\$74
Hip Strap - 2 Strap Style #2076	\$24
Hip Strap - Curved #2077	\$16. ⁵⁰
Hip Strap - Straight #2075	\$13
Hold Backs - Bio & Nylon Sewn Together #2081	\$39
Hold Backs - Single Ply #2080	\$34
Line Ring Strap at Hip includes Rings & Keepers #2092	\$6
Line Ring Strap for at Hip w/o Rings & Keepers (ea) #2101	\$4. ²⁵
Line Ring Strap for at Hames w/o Rings & Keepers (ea) #2102	\$3. ⁵⁰
Line Ring Straps for at Hames - includes Rings & Keepers (per pr) #2091	\$10. ⁵⁰
Lines - Economy Style #2272	\$50
Lines - Economy Style w/520 in Hand & Semi-Front #2271	\$61
Lines - Economy Style w/Bumpy Rein Grip w/Beaded Front #2273	\$70
Lines - Economy Style w/Smooth Rein Grip w/Beaded Front #2275	\$60
Lines - Hand parts only - in 1" Beta #2083	\$22
Lines - Lancaster County Style #2086	\$81
Lines - Lancaster County style - fronts only #2089	\$67
Lines - Lancaster County Style w/ 7/8" Bumpy Rein Grip in Hand #2084	\$88
Lines - Lancaster County Style w/Beta Braids in Hand #2094	\$124
Lines - w/Conway at Snap (Beta all the way) #2087	\$49
Rings on Shaft Loops (each) #00154	\$0.65
Saddle #2067	\$122
Shaft Loop Strap - Outside #2099	\$6
Shaft Loops - Bio Sheet (per pr) #2098	\$45
Shaft Loops - Straight Style #2104	\$43
Skirt #2100	\$15. ⁵⁰
Traces - Double Ply Bio #2111	\$85
Traces - Single Ply - Molded ends #2113	\$102
Tug Bearer #2115	\$6. ⁵⁰
Turn Back with Hardware - 1" opening #2120	\$14. ⁵⁰



- ROUNDS SPOTS ON BROW IS STANDARD
- FOR MORE OPTIONS ON OUR BROWBANDS, SEE PAGE 46
- FOR OPTIONS ON ROSETTES SEE PAGE 14
- FOR OPTIONS ON BITS SEE PAGES 32-35

Bridle Parts *Stainless Steel or Black*

Bit, Stainless Steel Snaffle w/Bar - 5" #25556	\$18
Bit, Stainless Steel Overcheck - 5" #25573	\$7. ⁵⁰
Blinds, Winker, Loops #2005	\$73
Brow, Plain #2010	\$4. ⁵⁰
Brow, Spotted #2011	\$8
Brow w/Hexagon Spots & Colored Trim #2009	\$12. ⁵⁰
Brow w/Hexagon Spots #2012	\$11
Brow w/Spots & Colored Trim #2008	\$9. ⁵⁰
Brow w/Weaver Chain & Colored Trim #2013	\$42
Combination - Crown Shaped #2018	\$29
Crown - Shaped w/ 3/4" 2-groove bio #2015	\$28
Crown - Straight #2014	\$17. ⁵⁰
Face Piece #2020	\$20
Martingale - U Part Only #2026	\$9. ⁵⁰
Martingale - U Style #2025	\$19. ⁵⁰
Martingale - V Style #2027	\$22
Rosettes, Bio (per pair) #2036	101/\$6. ⁵⁰ 281/\$8
Rosettes, Glass #02800	\$9. ⁵⁰
Rein Up - Double Strap #2028	\$21
Rein Up - Single Strap w/Rein End #2034	\$19. ⁵⁰
Rein Up - Single Strap w/Snap #2032	\$22
Side Check - Crown Shaped #2017	\$29
Side Check Complete #2042	\$37
Side Rein - Rounds only - Bio #2039	\$17
Side Reins -Rounds only - Bio w/Tab #2038	\$21
Throat Latch #2045	\$6

Add spots to your Harness

Face Pieceadd	\$9. ⁵⁰	Saddle Skirts add	\$45
Hip Strapadd	\$9	Crupper add	\$5. ⁵⁰
Martingaleadd	\$6. ⁵⁰	Breeching, single uptug add	\$7. ⁵⁰
Rein Up add	\$11	Breeching, double uptug add	\$23
Saddletop add	\$26		



Team Parts for Horse Size Harness

Also available for pony and mini sizes

BREAST
COLLAR COLLAR
HARNESS

Brake Strap w/snap (shown) per horse	#2205	\$81	☑	
Pole Strap 1" Bio/Nylon w/snaps	#2189	\$18.50	☑	1 st Pick
Pole Strap 1-1/4" x 42" old style	#2192	\$27	☑	2 nd Pick
Pole Strap 1-1/2" x 42" old style	#2193	\$27	☑	3 rd Pick
Pole Strap - nylon - ring style	#2199	\$6	☑	
Belly Backers w/snaps	#2188	\$41	☑	☑
Team Lines	#2198	\$102	☑	☑
Trace Carriers at Breeching with/snap	#2195	\$15.50	☑	☑
			1 Pair per horse	

Extra Parts

Evener Straps - 1" wide	#4206	\$45
Yoke Eye	#2196	\$27
Yoke Safety Strap	#2197	\$11



LOOKING FOR A BETTER HARNESS FOR YOUR HORSE?

THIS NEW PADDED SADDLE IS DESIGNED FOR YOUR HORSE!
[SEE PAGE 73 FOR COMPLETE HARNESS DETAILS]

Designed with experience in working for the "English" Driving community, this model is designed with built-in padding to spread out the weight of the saddle. Has a built in "gulley" for spine relief. Available with Extra deep gulley by request. Made with nice colored edges for the "showy" look, this is also available with black edges for a "Pappy-style" harness.

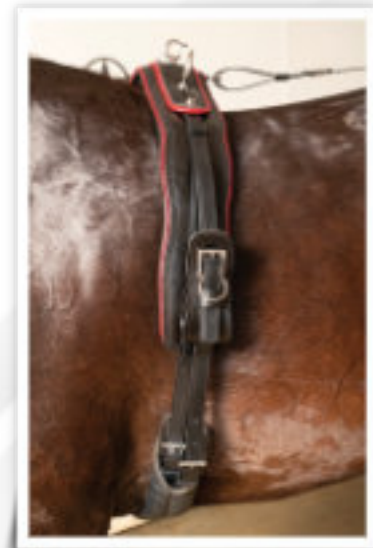
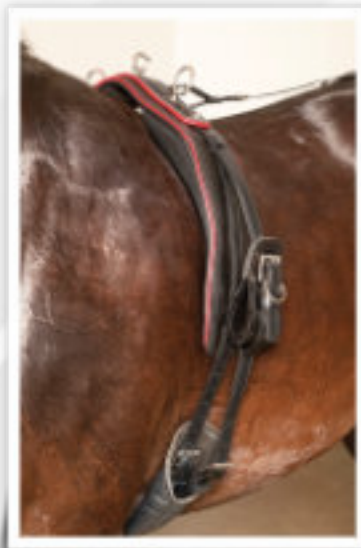

**SEE PAGE 51
FOR THE
MARATHON VERSION**

- TAKES PRESSURE OFF OF THE SPINE
- BUILT IN PADDING - SOME HORSES STILL NEED A THIN PAD

- SPREADS THE WEIGHT OF THE SADDLE ALL THE WAY DOWN INSTEAD OF JUST AT THE TOP
- AVAILABLE IN ALL COLORS

PULLEYS & POWER LINES

Power Drive

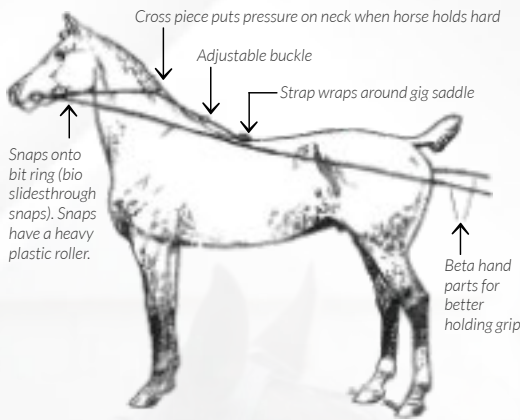

THIS DRIVING LINE IS AN IMPROVED METHOD OVER DRIVING LINE PULLEYS. IT DOES NOT HAVE A HEAVY PULLEY HANGING ON BIT AND HAS A CROSS PIECE OVER THE NECK WHEN HORSE IS LUGGING. THIS CROSS PIECE CAN BE ADJUSTED UP OR DOWN.

Power Drive Lines with Black or Stainless Steel Hardware

#2088 **\$82**

Power Drive Lines - Pony Size

#3549 **\$63**

Power Line Extensions

#2093 **\$23**



Shaft Strap for Pulleys

#2103 **\$61 pr**

For the horse that needs Pulleys but you don't want to fasten the lines back to the harness — you can now use this set up to fasten the lines to the shafts.

Shaft Straps Only. To be used with #2090 Pulleys

SHOULD I USE PULLEYS OR POWER DRIVES?

POWER DRIVES FOR HORSES THAT GET "HOT" OR LUGGERS THAT WON'T QUIT. PULLEYS ARE FOR THE HORSE THAT ONLY NEEDS IT ONCE IN A WHILE.

Snap with Square and Roller

#2090 **\$24 a set**

Designed to do the same thing as driving line pulleys. Large square lets you pass the front ends of your lines thru easily. This way you can quickly convert to average lines - also, with these you can use your average length lines instead of buying longer ones.

We also have a shorter model for horses that tuck their head in very far.

2 LENGTHS AVAILABLE:

Long (for horses with long necks)
10" length overall

Short (for horses with short necks)
6" length overall



Saddle Straps to use with Pulleys

#2095 **\$8 a set**

For the horse that needs Pulleys but you don't want to fasten the lines back to the harness — you can now use this set up to fasten the lines to the shafts.



MISC DRIVING PARTS, NECKROPES, OPEN CHEEKS

Nose Band with Single Strap Going Up Front (buckles into crown)

#2142 \$16.⁵⁰

Nose Band with Straps Going Behind Ears (caveson)

#2143 \$21

Nose Band 6 Ring Bit Style

#2145 \$20

Quick Hitch Converter - convert your existing harness to Quick Hitch

#6675 \$93

Available in 1" for Road Harness and 3/4" for Roadsters

Replacement Pads for Amish Saddle - New Style

#94758 \$24

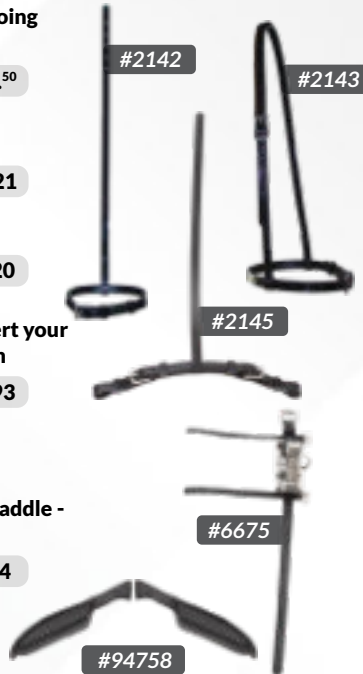

Neck Rope with Triple A Rope

#90065 \$18

Neck Rope with Triple A Rope w/chain at the end

#90067 \$32

Open Bridle Cheek Pieces with box loops

#2007 \$33

Open Bridle Cheeks

#2281 \$48

Poll Strap Beta

#2141 \$13.⁵⁰

Poll Strap Rope Style

#2138 \$13.⁵⁰

Trace Extensions with Roller Buckles, 1-1/2", 1-1/4".

#2180 \$38 pr



HARNESS DECORATIONS

ALL HEARTS ARE AVAILABLE WITH WHITE OR STAINLESS STEEL RINGS

5" Heart -Spotted with 1-1/2" Letter

#7047 \$28

5" Heart -Spotted with color

#7058 \$18



ALL VINYL COLORS AVAILABLE - SEE PAGE 5

5" Heart -Spotted with Horse #7046 \$16

5" Heart -Spotted empty center #7049 \$12.⁵⁰

2" Heart -Spotted #7041 \$8

Spots alone #22030 \$0.10

Diamonds alone #32640 \$0.10

Large Horse Shoe Horse Head with 7/8" wide Bio #7056 \$11

Plastic Rings in White or Black

7/8" #00000 \$0.20

1-1/4" #00003 \$0.35

1-5/8" #00006 \$0.50



#2135

THIS KEEPER KIT CONSISTS OF 60 KEEPERS - 30 BLACK AND 30 WHITE

There are 5 black & 5 white for the Martingale & Turn Back and for each side of the Rein Up & Hip Strap

Keeper Kit for Collar Harness #2135 \$24

Keeper Kit for Breast Harness #2136 \$29

If we Install + \$12

FOR REPLACEMENT KEEPERS ON YOUR HARNESS, PLEASE ASK. THESE KEEPERS ARE FOR DECORATIVE PURPOSES ONLY.



KEEPERS CAN ALSO BE BOUGHT INDIVIDUALLY:

White - 5/8" #59412 \$0.45

White - 3/4" #59413 \$0.45

White - 7/8" #59414 \$0.45

White - 1" #59415 \$0.45

Black - 5/8" #59442 \$0.45

Black - 3/4" #59443 \$0.45

Black - 7/8" #59444 \$0.45

Black - 1" #59445 \$0.45

STAINLESS KEEPERS

Up to 1", .75¢ ea. or 10 or more, .75¢ ea

Over 1", .75¢ ea. or 10 or more, .75¢ ea



Euro collars, Sunday Halters & Misc Parts



Euro Collars with Traces Sewn On

Not Padded with QR (needs an additional pad)	#2061	\$236
Pad for #2061	#17961	\$69
Padded with QR (built-in padding, no color)	#2062	\$340
Padded with QR (built-in padding, extra colored edge)	#2591	\$470

***ALL NEW MODELS HAVE SIDE OPENING (QR)
DUE TO BETTER COMFORT.**

**NEED
CONSTRUCTION
POUCHES?**

JUMP TO PG 6



Sunday Halter Crown #7118 \$14.⁵⁰

Sunday Halter adjustable Chin Strap #7119 \$6

Sunday Halter Cheek and Nose #7124 \$20

Sunday Halter Plain #7131 \$53

Sunday Halter with Spots #7132 \$53

Horse Dealer Halters

#7130 \$59

YOUR CHOICE OF COLOR TRIM
BIO COLORS, SEE PAGE 5



Kicking Strap

#2140 \$34



3-Ring Martingale (buckles into chokestrap)

#2023 \$12

3-Ring Martingale (goes to bellyband)

#2024 \$16



Yoke Eye

#2196 \$27



Ear Plugs

#10543 \$18

On the race track, these ear plugs pull out once they are on the homestretch, so the horse can hear the crowd and the other horses coming up behind him, which makes him pick up speed.

The ear plugs come with a long string that you can run back to the carriage, and will come out of the horse's ear if you pull on the string.

You can tie the short string to the horse bridle in case they fall out.



Ankle Boots

#20970 9" ankle boot \$32/ea

#20972 11" ankle boot \$39/ea

This model is for a horse that "nips" his ankles or legs.

#20974 15" knee boot \$46/ea

Knee boot model is made to be used with large part pointing up and covering the knee.



#52155 \$19/pr

This model is for a horse that hits ankles very hard.



DELUXE ROAD HARNESS

DELUXE ROAD HARNESS INCLUDES:

Sewn padding with colored edge on saddle, breast, and breeching.

Includes shaped crown, backing straps (holdbacks), snaffle and overcheck bits, lines, #2153 bridle, neoprene girth.

- Semi-gloss finish. Easy to clean, and has a nice look
- Doesn't show specks of dirt as soon as the shiny finish
- All deluxe road harnesses made in 281

Starting price with Deep V Breast
(Q.R. model #3701) - **\$1170**

Starting price with Black SS Hames
(#3702) **\$1075**



FEATURES...

Padded Saddle

This comes from the "English" driving community. We have made a similar saddle for 15+ years and only recently realized there is a need for this in our local community.

- Padding is all the way down to spread out the pressure instead of putting it all on the back
- New Saddle design has a medium gully in the top for the horse's spine. High gully available by request

Standard on Road Plus Harness
#3736 **\$255**

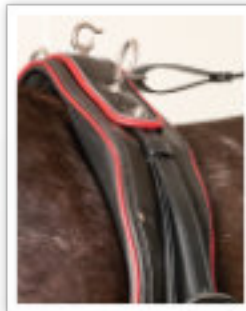

Double Hipstrap

Holds the breeching more level, doesn't sag like some of the single strap hipstraps do.

- Dee Rings let it "float" more easily
- Built-in padding so you don't need an extra pad

Standard on Road Plus Harness
#2076 **\$24**

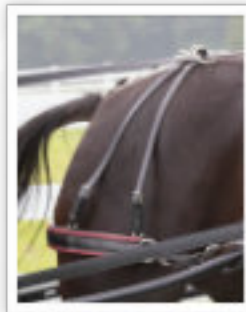

Padded Breastcollar

Standard on Road Plus Harness #3725 **\$330**

Padded Breeching

Standard on Road Plus Harness #3740 **\$98**

Neoprene Girth w/elastic insides

- For comfort: the neoprene cover helps the colts and horses with "thin skin"
 - Standard on Road Plus Harness
- 24" buckle tip to tip is standard for Road Harness, #6536 -24" **\$55**



Quick Hitch Bridle #2153 - \$188

- Standard with Deluxe Road Harness
- A classier bridle, blinds are smaller to get a showy look
- Choice of ornaments on Blinds: Diamond, Heart, Texas Star Rosettes or Horseshoe w/Horse Head

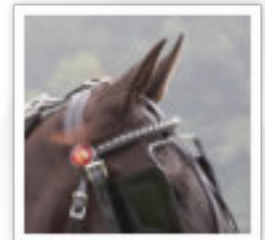

Shaped Crown

Fits to the horse's ears for increased comfort.

Wide Girth #6535\$85

Using a wide girth helps to spread out the pressure on the girth. Recommended by Chiropractors.



UPGRADES/OPTIONS...

Bridle #2158 **\$246**

Chiropractors tell us that reining a horse up with an overcheck can be harmful if you check up too hard (it will actually hurt their top-line muscles). Overchecks pull the nose up and out. Sidecheck bridles let the horse tuck-in their nose. Designed by a local trainer - he wanted a bridle that didn't look like a "pappy" bridle!

- Built-in nose band with "hanger" straps
- Padded nose and brow for comfort and class
- This style sidecheck is used with the "pleasure driving" community
- Recommended by Chiropractors
- Available with harness, or separately
- Choice of colored padding
- Available with ornaments on the blinds and on teardrop - Standard is without any ornaments



MINI & PONY BRIDLE, HARNESS & PARTS

INCLUDES: OVERCHECK BRIDLE, HOLDBACKS, SNAFFLE BIT, AND LINES. DOES NOT INCLUDE PADS.

SEE PAGES 11 & 12 FOR PADS

Mini Bridle, Harness & Parts - 101 or 281

Pony Bridle, Harness & Parts - 101 or 281

MINI B - 38" TO 43" • MINI A 32" TO 38" • X-SMALL MINI 28" TO 32" • PONY 44" TO 54"

Mini Harness & Bridle - Breast Collar Style	#3096	\$325
Belly Band	#3025	\$21
Bit - 3-1/2" Nickel Plated	#22236	\$7.50
Blinds with Winker	#3002	\$55
Breast Collar without Neck Strap	#3030	\$45
Breeching	#3033	\$25
Bridle - Overcheck Style	#3095	\$93
Brow Band	#3005	\$5
Crown	#3008	\$12
Crupper	#3035	\$14.50
Face Piece	#3010	\$7.50
Hames -Black Hybrid - with Solid Terrets	#95412	\$44
Hames -Black Hybrid -Solid Terrets - w/Chrome Balls	#94731	\$102
Hip Strap	#3038	\$9
Hold Backs with 56 Snaps	#3040	\$21
Lines 5/8" Wide with 56 Snaps	#3042	\$33
Line Rings & Straps on Hip	#3044	\$8
Neck Strap	#3046	\$8.50
Rein End for Mini	#3013	\$6
Rein Up	#3012	\$13
Rosettes - 1" (per pair)	#28013	\$3.50
Saddle 2" without Tree	#3048	\$59
Shaft Loops (a pair)	#3050	\$23
Throat Latch	#3017	\$6
Traces -1" Wide	#3054	\$37
Turn Back with Hardware	#3058	\$11.50

Pony Harness & Bridle - Breast Collar Style	#3591	\$470
With Black Hybrid Hames	#3592	\$485
With Stainless Steel Hames	#3595	\$560
Bridle - Overcheck or Sidecheck	#3590	\$126

Belly Band	#3530	\$22
Bit	#25227	\$10.50
Blinds with Winker and Loops	#3505	\$65
Breast Collar w/o Neck Strap	#3535	\$90
Breeching	#3540	\$39
Brow Band	#3508	\$4
Choke Strap for Breast Collar	#3565	\$12
Choke Strap for Collar	#3566	\$13.50
Crown	#3510	\$13.50
Crupper	#3035	\$14.50
Face Piece	#3514	\$8
Hame Strap -Single Ply	#2070	\$6.50
Hames -Black Hybrid without Terrets	#95870	\$55
Hip Strap	#3543	\$18.50
Hold Backs with 2001 Snaps	#3546	\$28
Line Rings and Strap on Hip	#3044	\$8
Line Rings & Strap with Hames	#3043	\$11
Lines - Beta with 2001 Snaps	#3548	\$38
Martingale	#3515	\$17
Neck Strap	#3550	\$26
Rein Up	#3516	\$16
Rosettes -1-1/4"	#28008	\$3.75
Saddle - 2-1/2" wide with Tree	#3553	\$93
Shaft Loops (a pair)	#3050	\$23
Throat Latch	#3520	\$6
Traces	#3558	\$54
Trace Carrier at Breeching (per piece)	#3685	\$10
Turn Back with Hardware	#3561	\$12

Mini Teams Sets & Parts - We Stock Mini Hames in 14"

Mini Team Set with Black Hames - w/o Balls - No Collars	#3193	\$730
Mini Team Set with Black Hames - with Balls -No Collars	#3194	\$790
Mini Team Set -Breast Collar Style	#3192	\$745

New Style Hook Up

Mini Collars -12" Thru 15" (SEE COLLAR PAGE)

Pole Strap w/Brake Strap, Mini, Snap	#2205	\$79
Pole Strap w/Brake Strap, Mini Economy	#2206	\$37
Belly Backers	#3072	\$26 pr
Brake Strap - for Team	#3078	\$9.50
Breast Collar - for Team	#3065	\$60
Choke Strap	#3068	\$11 ea
Lines -Mini Team -5/8" Wide with Snaps	#3075	\$54
Neck Strap - for Team	#3077	\$10
Pole Strap (per piece)	#3080	\$8.50 ea
Trace Carrier at Breeching (per piece)	#3083	\$6 ea

Pair Harness with Black Hybrid Hames	#3593	\$1175
Pair Harness with Breast Collar	#3594	\$1260

Lines -Pony Team -3/4" wide w/ Snaps	#3570	\$80
Brakestrap for pair	#3580	\$9.50
Polestrap for Breast (pair)	#3582	\$15
Belly Backers - Pony (per pair)	#3584	\$25
Breast Collar (pair)	#3586	\$104
Neckstrap (pair)	#3588	\$28

Cob Lightweight

Cob Lightweight Harness - 54" x 62"	#3950	\$515
-------------------------------------	-------	--------------

FINE SHOW HARNESS AND BRIDLE

BRIDLE OVERCHECK STYLE



BRIDLE SIDECHECK STYLE



TRACES



HARNESS



REINS



A FINE SHOW HARNESS FOR THE SHOW RING

Available in shiny Biothane for a patent look, or semi-shine with embossing for a dressed leather look. The Hardware is stainless steel - our standard is black. For colored inlay trim, see below for pricing. Reins (Lines) are 3/4" wide, black beta with buckles at the bit. No snaps unless requested. Other width reins available upon request. Shaft loops are french tug style. 3-ring Martingale is not included.

Shown with options: Weaver Chain on Brow, Deep V Breast With Clip, Colored Trim

Add colored trim:

Brow	\$8	Nose	\$8	Saddle	\$25
Breastcollar	\$25	Turnback	\$10		



AMISH DRIVING

Show Harness with overcheck bridle
#7775 **\$730**

Bridle Only - overcheck style
#7781 **\$190**

Show Harness with sidecheck bridle
#7776 **\$790**

Bridle Only - sidecheck style
#7779 **\$250**

Overcheck Bridle comes with half cheek snaffle bit and overcheck bit. Hexagon spots on the brow band. A noseband is a half nose, which goes just across the front of the nose. Brow and nose are not padded. The Overcheck going to saddle has just one strap, which adjusts with a conway and ends with a snap. No tear drop unless requested. Rosettes are stainless steel with a horsehead on, and a rope design along the edge.

Side Check Bridle includes a half cheek snaffle bit, show chain on browband and a full noseband band with 2 buckles. Noseband and browband are padded. Tear drop is included. Rosettes are stainless steel with a rope design along the edge.



Credits for photo: Climb Higher Equine Stable

Roadster Harness

Designed for the show ring. Lighter/finer than the Fine Show Harness. Originally designed for the Morgan Roadster Class but has also been used for other breeds in the last few years.

3 Ring Martingale

Any vinyl color available, **white & maroon are usually in stock**

\$925

VINYL COLOR OPTIONS: SEE PAGE 11

MISC AMISH PARTS

Cribbing Strap, Nut Cracker Style

#2125 **\$22**

Cribbing Strap, 1-1/2" wide

#2130 **\$11.50**

Cribbing Strap Miracle Collar, leather

#21285 **\$64**



#2130



#21285



#2125

Carriage **HALTERS**
with **CLASS!**

Choose Color of Trim:



Simple, on brow **\$59.00**

Fancy, on brow **\$73.00**

Simple, everywhere **\$81.00**

Fancy, everywhere **\$91.00**

Plain rosettes included in price.

For other rosette options see page 14.

Choose High Gloss (101)

or Leatherlook/Matte (281)



Front Blind with Straps -

to keep horse from looking forward.
Goes on to your bridle w/o any changes

#2001 **\$20**

Kicking Strap with Buckles (no photo)

#2140 **\$34**

Kicking Strap with Snaps (no photo)

#2132 **\$28**



#2001

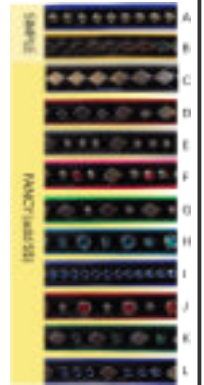

WORK BREAST COLLARS & NECK STRAPS

CHECK OUT THIS BREAST COLLAR!

When a horse gets a collar wound, switch to a breast Collar for a couple of weeks so its wound can heal up or use it on him ALL the time and save your collars. We have one farmer that bought 8. He only uses breast collars. He farms 80 acre and doesn't own one leather collar. These breast collars fit to any chain trace harness, just take the Hames off and hook up the Breast Collar. One size fits all. Can be modified to work with bio or belting traces. You may need to get shorter traces to work with this. Hook on breast needs to be modified + 2 pieces - #21034 (twisted connectors).

Complete Breast Collar w/ Neck Strap

Pole Breast Collar #2361 **\$190**

Side Breast Collar #2362 **\$170**

(Side is without the Dees in front or extra strap around the neck)

Breast Collar Only

Pole Breast Collar #2355 **\$142**

Side Breast Collar #2356 **\$102**

Neck Strap Only

Pole Neck Strap #2358 **\$68**

Side Neck Strap #2360 **\$67**

Brake Strap (for pole) #2359 **\$14.50**



WORK HORSE BRIDLE & HARNESS PARTS

NOW WITH STAINLESS STEEL HARDWARE!

Square Blind Bridle

Crown - 5/6 oz. Leather	#2321	\$7.50
Crown Strap	#2320	\$7.50
Throat Latch	#2326	\$8
Brow Band	#2314	\$6.50
Rosettes (per pair)	#28010	\$5
Blinds with Nose	#2317	\$55
Bit Straps (each)	#2311	\$5.50
Bit - Heavy Snaffle - Nickel Plated	#25561	\$6
Rein	#2400	\$24
Snap in Bit Strap - Stainless Steel (each)	#25064	\$4.50
Keepers in Bit Strap (each)	#09590	\$0.40

Pigeon Wing Bridle

Crown	#2334	\$19
Throat Latch	#2338	\$8
Brow Band	#2332	\$6
Rosettes (per pair)	#28010	\$5
Blinds with Winker	#2330	\$46
Face Piece	#2336	\$12.50
Bit Straps (each)	#2311	\$5.50
Bit - Heavy Snaffle	#25561	\$6
Snap in Bit Strap - Stainless Steel (each)	#25064	\$4.50
Keepers in Bit Strap (each)	#09590	\$0.40
Rein	#2400	\$24

Breeching Harness with Bio/Nylon Traces & Heel Chain

Wood Hames - Bolt Type	#99838	\$110
Hame Strap - Bio/Nylon	#2383	\$10
Hame Strap - Bio/Leather	#2384	\$11.50
Traces - Bio/Nylon with Heel Chain	#2404	\$170
Market Pad	#2414	\$30
Market Straps (per pair)	#2415	\$34
Belly Band with Conway & Holes	#2345	\$10.50
Belly Band with Conway & Buckle	#2346	\$20
Turn Back with Hardware	#2410	\$30
Hip Strap with Hip Drops & 667 Trace Carriers	#2395	\$54
Crupper	#2372	\$18
Breeching	#2365	\$43
Quarter Straps - Per Pair	#2418	\$40
Hame Strap - Single Ply for Lazy Strap (each)	#2385	\$7.50

Belting Traces with Heel Chains

#2403	\$100
-------	-------

Traces Bio/Nylon to insert Tandem Dees

#2405	\$20
-------	------

Front Gear Harness with Chain Traces

Wood Hames	#97924	\$88
Hame Hook - 900R (each)	#90006	\$1
Hame Hook Saver (each)	#2379	\$0.90
Hame Strap - Bio/Nylon	#2383	\$10
Hame Strap - Bio/Leather	#2384	\$11.50
Trace Chains Steel (pair) incl w/harness	#23021	\$28
Trace Chains SS (pair) not incl w/harn	#23031	\$95
Boots (pair)	#2369	\$47
Back Piece	#2343	\$36
Crupper	#2372	\$18
Turn Back with Hip Straps & all Hardware	#2411	\$85
Hip Strap with Hardware	#2390	\$22
Belly Band with Snap & Holes	#2349	\$11.50
Belly Band with Snap & Buckle	#2348	\$19.50
Trace Carriers (each)	#2407	\$12

Front Gear Harness with Bio/Nylon Traces & Heel Chain

Wood Hames - Bolt Type	#99838	\$110
Hame Strap - Bio/Nylon	#2383	\$10
Hame Strap - Bio/Leather	#2384	\$11.50
Traces - Bio/Nylon with Heel Chains	#2402	\$174
Market Pad	#2414	\$30
Market Straps per pair	#2415	\$34
Turn Back with Hip Straps to pass traces thru	#2412	\$63
Crupper	#2372	\$18
Trace Carriers (each)	#2407	\$12
Belly Band with Conway & Holes	#2345	\$10.50
Belly Band with Conway & Buckle	#2346	\$20

Breeching Harness with Chain Traces

Wood Hames	#97924	\$88
Hame Hook - 900R (each)	#90006	\$1
Hame Strap - Bio/Nylon	#2383	\$10
Hame Strap - Bio/Leather	#2384	\$11.50
Chain Traces	#23021	\$28
Boots (pair)	#2369	\$47
Saddle with Dees	#2344	\$42
Crupper	#2372	\$18
Turn Back with Hardware	#2410	\$30
Hip straps with Hip Drops & 667 Trace Carriers (used with #2410)	#2395 (pr)	\$54
Breeching	#2365	\$43
Quarter Straps - Hold Backs	#2418	\$40
Hame Strap - Single Ply for Lazy Strap (each)	#2385	\$7.50
#200 Snaps on Lazy Straps 1"-s/s (each)	#29004	\$3.25
Keepers on Lazy Straps (each)	#09590	\$0.40

AMISH WORK

BIOTHANE® WORK HARNESS

ALL WITH WOOD HAMES AND MOSTLY STAINLESS HARDWARE. BREAST CHAIN, TIE BACK AND BRIDLE NOT INCLUDED.

Front Gear Harness with

- Chain Traces #2303 **\$320**
- Bio - Nylon Traces with Chain Ends #2304 **\$435**
- Belting Traces with Chain Ends #2302 **\$375**

Breeching Harness with

- Chain Traces, includes Backer Straps, does not include Choke Strap #2305 **\$405**
- Bio - Nylon Traces, includes Backer Straps, does not include Choke Strap #2306 **\$515**
- Belting Traces, includes Backer Straps, does not include Choke Strap #2307 **\$455**

BUY 6 HARNESSES

GET 5% OFF IF PAID WITHIN 10 DAYS OF ORDER DATE

Teams Lines (Check Lines)

- Bio with Beta in Hands #2399 **\$108**

Tie Backs

- Bio#2400 **\$24**
- 3/16" Link Chain#2401 **\$29**



Hame Straps with Stainless Steel Buckles

- Bio & Nylon Sewn Together #2383 **\$10**
- Bio & Leather Sewn Together #2384 **\$11.50**
- Bio - Single Ply #2385 **\$7.50**



- Wood Hames For Front Gear Harness for Chain Traces #97924 **\$88**

- Wood Hames, Bolt Type for use with Bio - Plastic & Nylon Traces #99838 **\$110**

- Black Tubular Hames with Balls for Bio/Nylon Traces (all rings & loops are stainless steel) #52070 **\$114**



Miscellaneous

- Bridle - Square Blinds #2300 **\$140**

Bridles include Rein/ Tieback

- Bridle - Pigeon Wing Blinds #2301 **\$146**

Bridles include Rein/ Tieback

- Bridle - Economy Style #2310 **\$134**

Bridles include Rein/ Tieback

Breast Chain

- #2353 Steel **\$17**
- #2354 SS **\$26**

- Choke Strap with Links & Snaps #2370 **\$48**

- Hip Backer #2388 **\$64**

- Hip Strap Adapter w/ Buckle & Dee #2392 **\$9.50**

- Hip Strap Adapter w/ Buckle & Snap #2393 **\$11.50**

- Jockey Stick with Zinc Hardware #97906 **\$23**

- Jockey Stick with 1-1/4" Stainless Steel Snap & Stainless Steel Quick Link #2398 **\$33**

- Aluminum Jockey Stick (30% lighter than steel) with Stainless Steel Hardware & Stainless Steel Snaps #36345 **\$55**

- Trace Carrier with Snap & Ring Carrier #2408 **\$13 ea**

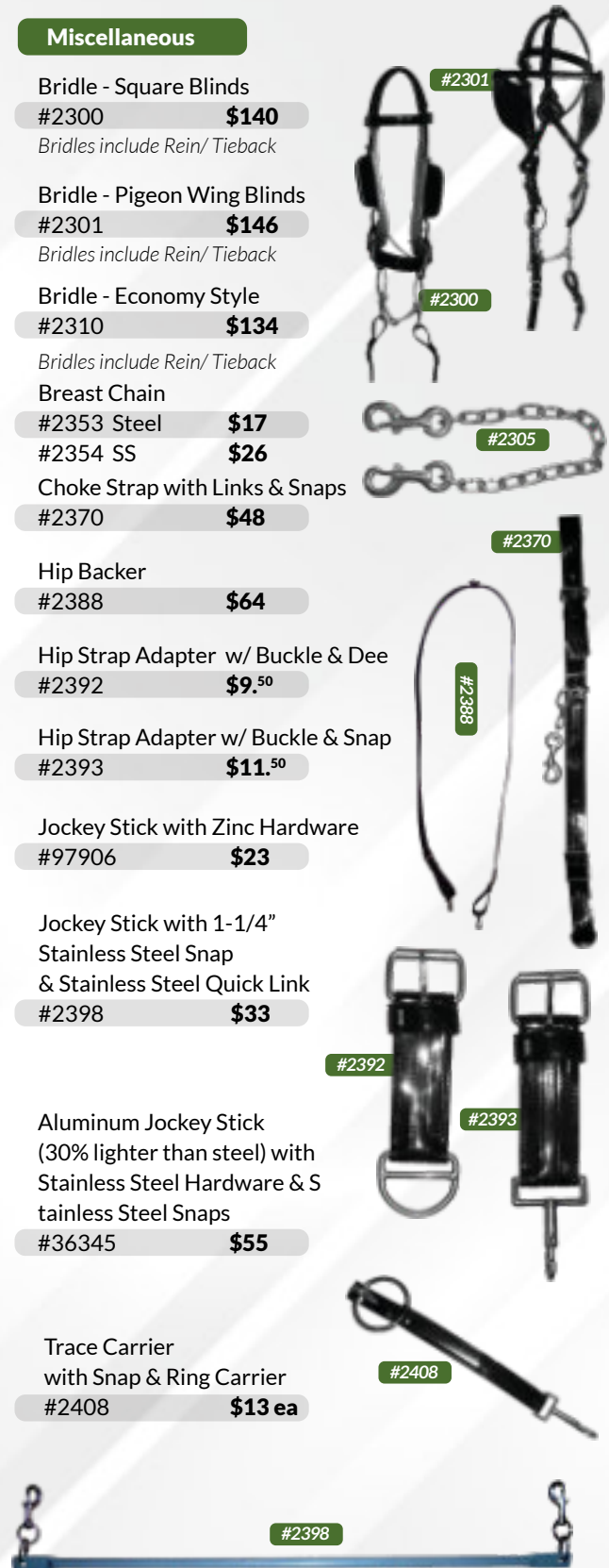

You don't learn anything being kicked a second time by a mule.

DRAFT CART HARNESS

A well built harness with a 5" wide saddle built over a stainless steel tree. Bit and all hardware are stainless steel. Traces are 2" wide with slotted ends. Chain ends are available at an additional cost. Breaching is 3" wide and padded, includes crupper and rein guides. This harness also works for team harness (additional parts needed).

ALSO AVAILABLE IN OTHER SIZES. COLLARS ARE NOT INCLUDED IN PRICE



Hame Cover

#7038 16" x 44" **\$142**



Black Tubular Hame Style

#2804 (plain) **\$1,010**
#2805 (spotted) **\$1,105**

Stainless Steel Hame Style

#2806 (plain) **\$1,170**
#2807 (spotted) **\$1,270**



3-Strap Breaching

Black Tubular Hame Style

#2808 (plain) **\$1,115**
#2809 (spotted) **\$1,255**

Stainless Steel Hame Style

#2810 (plain) **\$1,280**
#2811 (spotted) **\$1,420**

Breast Collar Style

#2802 (plain) **\$1,060**
#2803 (spotted) **\$1,220**



Breast Collar Style

#2800 (plain) **\$950**
#2801 (spotted) **\$1,070**



PLD OVER TO PG 13
FOR NAME PLATES

DRAFT PARTS FOR CART HARNESS

DRAFT WORK

		PLAIN	SPOTTED
Belly Band	#2813	\$36	----
Bit	#47707	\$13.50	----
Bit Straps (per pair)	#2626	\$11.50	----
Blinds with Nose Band	#2628	\$82	#2629 \$94
Breast Collar with #5705 Buckles (w/o neck strap)	#2815	\$176	#2816 \$206
Breast Collar with #49 Buckle & Stainless Steel Loops (w/o neck strap)	#2817	\$180	#2818 \$208
Breast Collar Neck Strap Alone	#2820	\$45	#2821 \$52
Breeching with #5705 Buckles (2 strap)	#2824	\$96	#2825 \$128
Breeching with #49 Buckles & Stainless Steel Loops (3 strap)	#2658	\$130	#2659 \$164
Bridle (comes with stainless steel bit)	#2600	\$212	#2601 \$238
Brow Band	#2631	\$8	#2632 \$12
Choke Strap	#2826	\$24	----
Choke Strap - Fancy Style - No Spots - with 3 Ornaments	#2827	\$62	----
Choke Strap - Fancy Style - Spotted - with 3 Clusters		----	#2828 \$65
Choke Strap with Martingale	#2829	\$53	----
Crown	#2635	\$26	----
Crupper Fork	#2672	\$14	----
Crupper (without Fork)	#2372	\$18	----
Face Piece with Overcheck	#2639	\$15	----
Hame Straps (bio & nylon sewn together for strength) per piece	#2383	\$10	----
Hold Backs (extra long for Draft, includes snaps)	#2831	\$48 pr.	----
Lines without Snaps	#2835	\$60	----
Lines Guides for Hip	#2832	\$12 pr.	----
Rosettes	#28010	\$5	----
Saddle 5" wide	#2838	\$196	#2839 \$220
Shaft Loops	#2843	\$65 pr.	----
Sidecheck with Conway Gag	#2642	\$41	----
Tear Drop	#2644	\$8.50	#2645 \$19
Throat Latch	#2647	\$8	----
Traces with Black Bolt Connector & Clip at Front, Slots at Back	#2857	\$148	#2858 \$158
Traces with Stainless Steel Bolt Connector at Front, Slots in Back	#2859	\$174	#2860 \$188
Tubular Hames, Black, for 1 Horse	#52070	\$114	----
Turn Back, Spider with 2 Strap Hip Drop	#2847	\$75	#2848 \$90
Turn Back, Spider with 3 Strap Hip Drop	#2852	\$164	#2853 \$214
Winker	#2648	\$8.50	----

OPTIONS FOR SINGLE DRAFT HARNESS

HEEL CHAINS ON TRACES INSTEAD OF SLOTSADD HEEL CHAIN PRICES (SEE DRAFT CONVERSION PARTS PAGE 82)

Trimming Single Draft in Color

Breast Collar, Trimming	#2819	\$17
Breeching, Trimming	#2660	\$17
Brow, Trimming		\$3.50
Neck Strap, Trimming	#2822	\$7.50
Saddle, Trimming	#2840	\$21
Spider, Trimming	#2849	\$10

DRAFT TEAM SETS - FARM & LOGGING STYLE - PARADE STYLE

All Team Sets come with stainless bits and stainless steel hardware. Some are priced with chrome plated (CP) heel chains. These draft team sets are well built! They have rolled edged padding on crowns, belly bands and breeching for comfort. Traces are 5 ply which is strong enough for draft pulling contests. Priced without cruppers.

ALL NEW ENGLAND DEE RING HARNESSES ARE PRICED WITH THE TRIM YOKES

*NOTE: CP = CHROME PLATED, S.S = STAINLESS STEEL AND N.E. = NEW ENGLAND

#2602 Draft Team Set, Black Hames, C.P Heel Chains, No Spots, 2 - Strap Spider	\$1,880
#2603 Draft Team Set, Black Hames, C.P Heel Chains, Med. Spotting, 2 - Strap Spider	\$2,040
#2604 Draft Team Set, Black Hames, C.P Heel Chains, Heavy Spotting, 2 - Strap Spider	\$2,160
#2605 Draft Team Set, S.S Hames, S.S Heel Chains, No Spots, 2 - Strap Spider	\$2,240
#2606 Draft Team Set, S.S Hames, S.S Heel Chains, Med. Spotting, 2 - Strap Spider	\$2,390
#2607 Draft Team Set, S.S Hames, S.S Heel Chains, Heavy Spotting, 2 - Strap Spider	\$2,510
#2608 Draft Team Set, Black Hames, C.P Heel Chains, No Spots, 3 - Strap Spider	\$2,160
#2609 Draft Team Set, Black Hames, C.P Heel Chains, Heavy Spotting, 3 - Strap Spider	\$2,530
#2610 Draft Team Set, S.S Hames, S.S Heel Chains, No Spots, 3 - Strap Spider	\$2,520
#2611 Draft Team Set, S.S Hames, S.S Heel Chains, Heavy Spotting, 3 - Strap Spider	\$2,890
#2612 Draft Team Set w/N.E. Dee Ring Traces, Black Hames, C.P Heel Chains, No Spots, 2 - Strap Spider	\$2,030
#2613 Draft Team Set w/N.E. Dee Ring Traces, Black Hames, C.P Heel Chains, Med. Spotting, 2 - Strap Spider	\$2,170
#2614 Draft Team Set w/N.E. Dee Ring Traces, Black Hames, C.P Heel Chains, Heavy Spotting, 2 - Strap Spider	\$2,270
#2615 Draft Team Set w/N.E. Dee Ring Traces, S.S Hames, S.S Heel Chains, No Spots, 2 - Strap Spider	\$2,390
#2616 Draft Team Set w/N.E. Dee Ring Traces, S.S Hames, S.S Heel Chains, Med. Spotting, 2 - Strap Spider	\$2,540
#2617 Draft Team Set w/N.E. Dee Ring Traces, S.S Hames, S.S Heel Chains, Heavy Spotting, 2 - Strap Spider	\$2,630
#2618 Draft Team Set w/N.E. Dee Ring Traces, Black Hames, C.P Heel Chains, No Spots, 3 - Strap Spider	\$2,310
#2619 Draft Team Set w/N.E. Dee Ring Traces, Black Hames, C.P Heel Chains, Heavy Spotting, 3 - Strap Spider	\$2,650
#2620 Draft Team Set w/N.E. Dee Ring Traces, S.S Hames, S.S Heel Chains, No Spots, 3 - Strap Spider	\$2,680
#2621 Draft Team Set w/N.E. Dee Ring Traces, S.S Hames, S.S Heel Chains, Heavy Spotting, 3 - Strap Spider	\$3,010

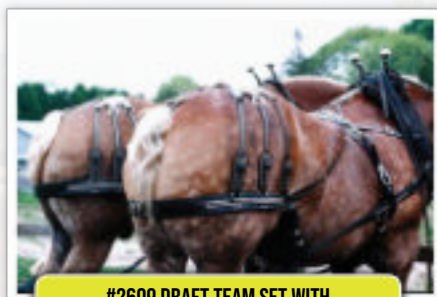

**#2609 DRAFT TEAM SET WITH
3-STRAP BREECHING IN HEAVY SPOTTING**

Crupper forks not included in prices

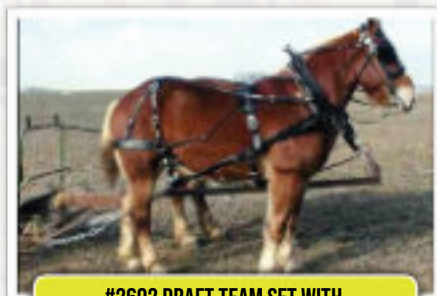

**#2602 DRAFT TEAM SET WITH
2-STRAP BREECHING, PLAIN**

Crupper forks not included in prices

ALL NEW ENGLAND DEE RING HARNESSES ARE PRICED WITH THE TWIN YOKES!



**#2606 DRAFT TEAM SET, S.S. HAMES, S.S. HEEL CHAINS,
MED. SPOTTING, 2-STRAP SPIDER**

Crupper forks not included in prices

DRAFT CONVERSION PARTS

Heel Chain Trace Converter

Trace Converter (heel chain not included)

2"	#2789	\$20 pr.
1-1/2"	#2790	\$18. ⁵⁰ pr.

Stainless Steel Heel Chains with Swivels

2"	#45592	\$21 ea.
1-1/2"	#45590	\$23 ea.

Stainless Steel Heel Chains without Swivels

2"	#2794	\$28 ea.
1-1/2"	#7580	\$17 ea.

Chrome Plated Heel Chains with Swivels

2"	#45584	\$15 ea.
1-1/2"	#45582	\$12.50 ea.



Buckle this to your slotted trace to convert it to a heel chain trace

#2789



Slotted Trace Converter

#2791 **\$34 pr**

Snap this to your heel chain to convert it to a slotted trace. Has strong stainless steel snap. 1-1/2" wide.

ATTACH THESE PARTS TO YOUR DRAFT TEAM TO GO SINGLE



Single Reins

Line Guides

Hold Back with Snaps (per pr)	#2831	\$48
Line Guides for Hip (per pr)	#2832	\$12
Line Guides for Hip w/Stainless Steel Snaps (per pr)	#2833	\$19. ⁵⁰
Single Lines without Snaps	#2835	\$60
Heel Chain Covers (1 set for 1 horse)	#2795	\$18. ⁵⁰



Hold Backs

Shaft Loop Attachments

Draft Size Attachment - Complete (pictured)	#2846	\$97
Draft Shaft Loop Belly Strap	#2845	\$12. ⁵⁰
Draft Shaft Loop Carrier Straps	#2844	\$19. ⁵⁰ pr.
Draft Shaft Loops (per pr)	#2843	\$65 pr.
Haflinger Shaft Loop Attachment - Complete	#7600	\$65
Haflinger Shaft Loop Belly Strap	#7599	\$9. ⁵⁰
Haflinger Shaft Loop Carrier Straps	#7598	\$17. ⁵⁰ pr.
Haflinger Shaft Loop	#2098	\$45 pr.

(Haflinger size is not built quite as heavy as draft size)



#2846



#2098

DRAFT TEAM PARTS

All team parts are sold per horse, except traces and lines. Traces are sold per set (2 horses)

	PLAIN	MED SPOTTED	HEAVY SPOTTED
Belly Band	#2650 \$24	-----	-----
Belly Band - Wrap Style for Pulling	#2651 \$57	-----	-----
Belly Band - Wrap Style - Extra Wide	#2652 \$73	-----	-----
Billets (pair)	#2654 \$23	-----	-----
Bit	#25557 \$13.50	-----	-----
Bit Straps (per pair)	#2626 \$11.50	-----	-----
Blinds with Nose Band	#2628 \$82	#2629 \$94	-----
Breeching - 2 Strap - Conway Style	#2656 \$51	#2657 \$68	-----
Breeching - 3 Strap with #49 Buckles & SS Loops	#2658 \$130	-----	#2659 \$164
Bridle (comes with stainless steel bit)	#2600 \$212	-----	#2601 \$238
Brow Band	#2631 \$8	#2632 \$12	-----
Check Strap - Single Style - goes to ring on rump (per pc)	#2664 \$8.50	-----	-----
Check Strap - Double Style - goes to breeching dees (per pc)	#2665 \$23	#2666 \$43	-----
Crown	#2635 \$26	-----	-----
Crupper (without fork)	#2372 \$18	-----	-----
Crupper Fork (without crupper)	#2672 \$14	-----	-----
Face Piece, Overcheck Style	#2639 \$15	-----	-----
Rear Overcheck	#2640 \$21	-----	-----
Hame Strap (bio & nylon)	#2383 \$10	-----	-----
Hame Strap (bio & leather)	#2384 \$11.50	-----	-----
Lazy Straps with Pockets (pair)	#2677 \$62	#2678 \$69	#2679 \$76
Lines - Team Style - 1" wide	#2680 \$99	-----	-----
Lines - 4 Up Style - 1" wide (Lead or Swing Horse Lines)	#2681 \$134	-----	-----
Lines - 6 Up Style - 1" wide (Lead Horse Lines)	#2682 \$160	-----	-----
Lines - 3 Abreast Style - 1" wide	#2683 \$162	-----	-----
Lines - 4 Abreast Style - 1" wide	#2674 \$182	-----	-----

NOTE: ALL LINES ARE PRICED WITH BETA HAND PARTS AND NO SNAPS

Market Pad	#2684 \$53	#2685 \$66	#2686 \$86
Market Straps (pair)	#2690 \$33	-----	-----
Pole Straps with 1616 Snap (each)	#2694 \$64	-----	-----
Quarter Straps (pair)	#2696 \$42	-----	-----
Rosettes (pair)	#28010 \$5	-----	-----
Side Backer Straps - 5705 Style - 1-1/2" x 74" (pair)	#2698 \$47	-----	-----
Side Backer Straps - 5705 Style - 1-1/2" x 60" (pair)	#2699 \$42	-----	-----
Side Backer Straps - Conway Style - 1-1/2" wide Adj. from 48" - 60" (pair)	#2700 \$64	-----	-----
Sidecheck with Conway Gag	#2642 \$41	-----	-----
Spider - 2 Strap - Conway Style	#2702 \$93	#2703 \$104	#2704 \$120
Spider - 3 Strap - #49 Style	#2707 \$172	#2708 \$194	#2709 \$224
Strap from Jockey Strap or upside down Hook to Hame Bio/Nylon Hame Strap - 1" - 21"	#2383 \$10	-----	-----
Tear Drop	#2644 \$8.50	#2645 \$19	-----
Throat Latch	#2647 \$8	-----	-----
Traces w/Black Hardware & Chrome Plated Heel Chains (per set)	#2718 \$330	#2719 \$355	#2720 \$365
Traces w/Stainless Steel Hardware & Stainless Steel Heel Chains (per set)	#2722 \$415	#2723 \$440	#2724 \$455
Traces New England Dee Ring Style w/Black Hardware (per set)	#2782 \$460	#2786 \$480	-----
Traces New England Dee Ring Style w/Stainless Steel Hardware (per set)	#2783 \$560	#2784 \$580	-----
Winker	#2648 \$8.50	-----	-----

Trimming Draft Sets in Color

Breeching - Trimming	#2660	\$17 ea.	Spider - Trimming	#2705	\$7.50 ea.
Market Pad - Trimming	#2687	\$8 ea.	Brow - Trimming		\$3.50 ea.

HAFLINGER TEAM SETS - FARM, LOGGING STYLE - ALSO SINGLE HARNESS

ALL HARDWARE IS STAINLESS STEEL - NO COLLARS INCLUDED IN THESE PRICES...SEE PAGE 10

*NOTE: CP =CHROMED PLATED, S.S. = STAINLESS STEEL

TEAM SETS - PLAIN

	PLAIN	SPOTTED
Bridle	#7500 \$134	#7501 \$182
Halfinger Team Set with Black Hames, Stainless Steel Hardware, Chrome Plated Heel Chains - 2 Strap	#7502 \$1,375	#7503 \$1,520
Halfinger Team Sets w/Stainless Steel Hames, Stainless Steel Hardware, Stainless Steel Heel Chains - 2 Strap	#7504 \$1,810	#7505 \$1,990
<i>For 3 Strap Team Set</i>	<i>add \$105</i>	<i>add \$365</i>
Blinds	#7508 \$49	#7509 \$77
Brow Band	#7510 \$5	#7511 \$10.50
Crown	#7512 \$18	-----
Nose Band	#7513 \$4.50	-----
Side Check with Conway Gag	#7515 \$30	-----
Teardrop	#7516 \$4.75	-----
Teardrop with Ornament	#7517 \$13.50	-----
Throat Latch	#7518 \$5	-----
Winker	#7519 \$6	-----
Belly Band	#7520 \$18.50	-----
Billets per pair	#7525 \$18.50 pr.	-----
Breeching	#7528 \$33	#7529 \$42
Check Strap - Double Style (per piece)	#7535 \$17 ea.	-----
Check Strap - Single (per piece)	#7536 \$5.50 ea.	-----
Lazy Strap (per pair)	#7538 \$15 pr.	-----
Lines - Team - 1" wide	#7540 \$92	-----
Market Pad	#7550 \$42	#7551 \$55
Market Strap (per pair)	#7555 \$26	-----
Pole Strap with 1616 Snap (per piece)	#7560 \$59	-----
Quarter Straps (per pair)	#7562 \$26 pr.	-----
Spider - 2 Strap - Conway Style	#7565 \$84	#7566 \$94
Trace w/Black Hardware & Chrome Plated Heel Chains - for 2 horses	#7570 \$270	#7571 \$265
Trace with Stainless Steel Hardware & Stainless Steel Heel Chains	#7575 \$380	#7576 \$405
Shaft Loop Attachment Straps with Snap	#7598 \$17.50 pr.	-----
Straps with 2 Buckles & Keeper	#7599 \$9.50	-----
Shaft Loop Attachment - Complete	#7600 \$65	-----

SINGLE

	PLAIN	SPOTTED
Halfinger Single with Breast Collar	#7700 \$695	#7701 \$845
Halfinger Single with Black Driving Hames	#7702 \$685	#7703 \$805
Halfinger Single with Stainless Steel Driving Hames	#7704 \$755	#7705 \$825
Breast Collar with # 49 Buckle	#7720 \$138	#7721 \$172
Neck Strap	#7722 \$29	#7723 \$36
Breeching # 49 Style	#7730 \$74	#7731 \$99
Crupper Fork	#7734 \$9	-----
Lines - Single - 3/4" wide	#7736 \$48	-----
Saddle - 4" wide	#7745 \$128	#7746 \$152
Shaft Loops (per pair)	#2098 \$45 pr.	-----
Traces with Slots	#7750 \$82	#7751 \$93
Turn Backs with Spider	#7755 \$82	#7756 \$100
Mini Team Set - Farm and Logging Style	#2863 \$1,030	

DRAFT TEAM HARDWARE

ALL HARDWARE IS PRICED PER SET (FOR 2 ANIMALS) UNLESS OTHERWISE NOTED.

HAMES - ALL HAMES ARE PRICED PER SET (2 ANIMALS)

Black Tubular with Stainless Steel Rings & Balls	#52070	\$228
Black Tubular with Stainless Steel Rings & Balls Pulling Style	#62085	Call for price
Stainless Steel Tubular w/ Stainless Steel Hardware	#52050	\$550/set
Stainless Steel Tubular w/ Stainless Steel Hardware Pulling Style	#62080	\$1,580

SIDE BACKER HARDWARE

Jockey Loop Rings for on Billets when using Side Backers	#36300	takes 4 pcs x \$6 ea.
Jockey Snaps - Stainless Steel	#60800	takes 4 pcs x \$12 ea.
New England Side Backer Hook - #499, 1-1/2" Black	#49900	takes 4 pcs x \$7.50 ea.
New England Side Backer Hook - #499, 1-1/2" Stainless Steel	#49901	takes 4 pcs x \$35 ea.
Twin Yokes - Draft Size is 23 1/2" overall - Haflinger size is 20-1/2" (S.S.)	#38572	takes 2 pcs at \$99/pr.

TRACE HARDWARE

Bolt Connectors - #21 Black, 1-1/2"	#99001	takes 4 pcs x \$5.50 ea.
Bolt Connectors - #21 Black, 2"	#99003	takes 4 pcs x \$7 ea.
Bolt Connectors - #21 Stainless, 1-1/2"	#99005	takes 4 pcs x \$13 ea.
Bolt Connectors - #21 Stainless, 2"	#99006	takes 4 pcs x \$13.50 ea.
Bolt Connectors - #212 Black, Pulling, 2"	#99010	takes 4 pcs x \$15 ea.
Bolt Connectors - #212 Stainless, Pulling, 2"	#99011	takes 4 pcs x \$19.50 ea.
Clips - #989, Black - 3 Hole, 1-1/2"	#87901	takes 4 pcs x \$3 ea.
Clips - #989L, Black - 5 Hole, 2"	#87602	takes 4 pcs x \$4.75 ea.
Clips - #988 Stainless - 3 Hole, 1-1/2"	#87605	takes 4 pcs x \$11 ea.
Clips - #870 Stainless - 5 Hole, 2"	#87606	takes 4 pcs x \$12.50 ea.

HEEL CHAINS

Chrome Plated with Swivel - 2"	#45584	takes 4 pcs x \$15 ea.
Stainless Steel with Swivel - 2"	#45592	takes 4 pcs x \$21 ea.
Stainless Steel without Swivel - 2"	#2794	takes 4 pcs x \$28 ea.

HEEL HOOKS

Black - #444 - 2"	#44472	takes 4 pcs x \$12.50 ea.
Stainless Steel - #444 - 2"	#81105	takes 4 pcs x \$14 ea.

NEW ENGLAND STYLE TRACE DEE

Black over Mag. Bronze - #487 - 2"	#32620	takes 4 pcs x \$21 ea.
Stainless Steel - #487 - 2"	#32630	takes 4 pcs x \$24 ea.

HAME FASTENERS (PER PIECE)

Hame Fastener # 83 Work - Black	#52045	\$24
Hame Fastener # 84 Pulling - Black	#52046	\$40
Hame Fastener # 83 Work - Chrome Plated	#52047	\$53
Hame Fastener # 84 Pulling - Stainless Steel	#52048	\$74

DRAFT SHOW HARNESS

#2901 SINGLE SHOW HARNESS

SINGLE SHOW HARNESS PRICES INCLUDE:

Housing, Buxton Show Bit, Shaft Loop Pockets, Single Hold Backs and Single Reins.

Your choice of nose band style either Caveson Style or Front Nose Band Style.

PRICES DO NOT INCLUDE COLLARS - SEE PAGE 10

Draft Size: **\$2,750**

Haflinger Size: **\$2,650**

#2902 TEAM SET SHOW HARNESS

TEAM SET SHOW HARNESS PRICES INCLUDE:

Housing, Buxton Show Bit, and Team Reins.

PRICES DO NOT INCLUDE COLLARS - SEE PAGE 10

Draft Size: **\$5,280**

Haflinger Size: **\$5,180**



Bee Tree Trail

Belly Band Complete - Padded Style	#2925	\$80
Belly Band without Outside Strap	#2926	\$67
Bit for Show	#25520	\$44
Blinders and Winker	#2908	\$88
Breeching	#2930	\$126
Brow Band	#2910	\$39
Choke Strap with 3 Ornaments	#2827	\$62
Clover - per piece	#2933	\$48
Connector Strap	#2935	\$16
Crown	#2912	\$23
Crupper	#2938	\$17. ⁵⁰
Crupper Fork	#2939	\$11. ⁵⁰
Draft Show Bridle w/Buxton Show Bit	#2900	\$305
Housings w/Show Chain & 9 Ornaments - each	#85100	\$375
Kidney Drop	#2940	\$99
Lazy Straps - Plain - per pair	#2942	\$42
Lazy Strap - Fancy - per pair	#2943	\$78
Martingale Show Chain & Ornament	#2947	\$182
Nose Band with Caveson Strap	#2914	\$36
Pole Straps or 1616 Outfits - per piece	#2950	\$100
Rosettes - per pair	#27855	\$11
Saddle	#2955	\$695
Show Hames #821 - per pair - for 1 horse	#82110	\$415
Show Hames #821 - per set - for 2 horses	#82100	\$835
822 Show Hooks #821 - per pair - for horse	#82105	\$98
Side Check with Fine Chain	#2916	\$63
Spider	#2959	\$154
Tear Drop	#2918	\$19
Throat Latch	#2920	\$11
Traces for Single - per pair	#2962	\$228
Traces for Team - per set	#2963	\$415

Nose Bands

Front Nose Band Style

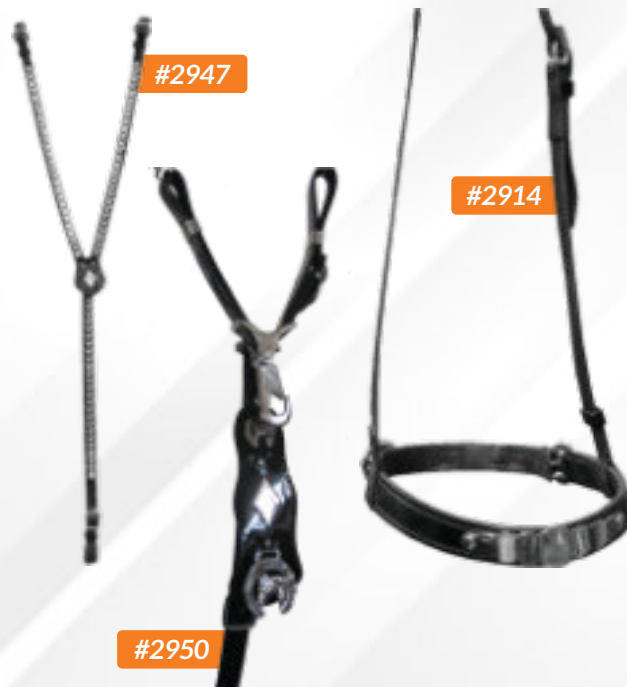

INDEX

Amish Road Harness & Parts.....	65-76
Bells.....	9
Belts.....	7
Bits.....	32-35
Breast Collars, super V.....	49
Breast Collars, Work.....	76
Breast Collars, Padded & Pl.....	48
Breast Collars, Quick Release.....	48
Breast Collars, Race.....	27
Bridles Padded w/accessories.....	45
Bridles Race & Accessories.....	25-26
Brooms.....	8
Burrs	31
Buxtons.....	28
Caution Signs	60
Cavesons Race	24
Collars.....	10
Color Chart	5
Construction Pouches.....	6
Corner Balls.....	7
Couplers Quick Hitch.....	23
Cribbing Straps.....	76
Crupper Towels.....	23
Cruppers, Pleasure.....	53
Cruppers, Race.....	23
Deluxe Road Harness.....	73
Diaper Bag.....	9
Draft Cart Harness.....	79
Draft Cart Harness Parts.....	80
Draft Conversion Parts.....	82
Draft Show Harness.....	86
Draft Team Hardware.....	85
Draft Team Parts	83
Draft Team Sets	81
Ear Plugs.....	27,72
Euro Collars.....	50,72
Evener Straps	57,69
False Martingales	50
Fine Show Harness.....	75
Flower Pot Holders	7
Four in Hand Parts	56,57
Gates.....	9
Gifts.....	7-9

Girths, Padded & Pleasure.....	51
Girths, Race.....	23
Glasses.....	23
Gloves, Bionic.....	7
Halfinger Team Sets.....	84
Halter, Carriage.....	72
Halters and Tack.....	16-20,72
Hame Straps.....	47,59,68,74,77
Hames & Accessories.....	47,68,78
Harness Bag.....	59
Harness Decorations.....	71
Harness Hooks.....	8
Harness, Padded.....	36
Harness, Pleasure.....	38
Head Pole Straps.....	23
Head Poles.....	31
Hearts, Decorative.....	13,71
Heel Chains.....	82
Hold Backs.....	54,68,74,77,82
Hole Punch items.....	59
Hoof Dressing.....	63
Hopple Hangers.....	30
Hopples, Grazing.....	8
Hopples, Racing.....	30
Jockey Stick.....	78
Keepers, Decorative.....	71
Kicking Straps.....	57,72
Knee Spreader.....	15,28
Leads.....	19
Line Accessories, Race.....	24
Lines, Long.....	15
Liniments.....	63,64
Marathon Misc Accessories.....	59,62
Marathon Pads.....	61
Murphy Blinds.....	27
Muzzles, Grazing.....	8
Name Plates.....	13,19
Neck Ropes.....	71
Noseband.....	47,50,65,71
Nosebands, Race.....	24
Number Holders.....	59
Open Cheek Pcs.....	25,45,71
Ornaments.....	13,14

Pads, Waffle - Air Flow (Pleasure).....	62
Pads, Vinyl/Neo (Amish).....	11
Pads, Vinyl/Neo (Race).....	29
Pen Holders.....	7
Pigeon Wing Bridle & Parts.....	77,78
Plumes.....	13
Power Drive Options.....	70
Rabbits Products.....	63,64
Race Accessories.....	23-31
Race Harness.....	21,22
Reflective Harness Items.....	65
Rein Guides.....	53
Riding Tack.....	20
Roadster Harness.....	75
Rosettes.....	14
Saddles, Padded & Pleasure.....	51
Safety Belt, Marathon.....	59
Shadow Roll.....	26
Shaftloops, French Tug.....	52
Shaftloops, Quick Release.....	52
Snap Shackles & Accessories.....	13
Snaps.....	13
Spares Kits.....	59
Square Blind Bridle & Parts.....	77
Stall Gates.....	9
Stirrups.....	8
Sulky Attachments.....	23
Surcingles, Training.....	15
Sweat Stick.....	8
Tandem Parts.....	58
Terms.....	3
Three Ring Martingale.....	57,72
Tie Backs.....	78
Tie Downs, Carriage.....	59
Trace Carriers.....	54,58,69,74,75
Trace Converter.....	58,82
Trace Extensions.....	58,71
Training Equipment.....	15
Turnbacks, Quick Release.....	53
Wallets.....	7
Whips.....	31,60
Wormer.....	63
Wrench Case.....	8



435 Churchtown Road
Honey Brook, PA 19344

Know someone that would like our catalog? Send us their name & address, and we'll send one to them at no charge.

4-In-Hand PAGE 36



Deluxe Road Harness PAGE 73



Bits PAGES 32-35



Neck Sweats
PAGE 15



Stapled Keepers



standard on our "Deluxe" Harnesses

Belts PAGE 15



Wooden Sweat Sticks
PAGE 8

